

ALPS

MD-5500 MD-5500P

**Online User's Guide
for Windows 95/98/Me,
Windows 2000,
Windows XP
and Windows Vista 32**

Contents

Table of Contents

Various Printing Operations	4
Printing on Photographic-Quality Paper (4" x 6")	10
Printing on Photographic-Quality Labels	16
VPhoto Color Printing on VPhoto Print Film	22
VPhoto Color Printing on VPhoto Paper	25
VPhoto Color Printing on Plain Paper	28
VPhoto Color Printing on Photo Realistic Labels	31
Full Color & Photo Realistic Finishing (Glossy Finish)	34
Printing Method	34
Printing in Spot Color	36
Single Ink Printing	37
Multiple Inks Printing	41
Simultaneous Metallics & CMYK Inks Printing	49
Printing in Foil Color	56
Types of Foil Color Printing	56
Single Foil Color Printing	57
Multi Foil Color Printing	61
Simultaneous Full Color + Foil Color Printing	67
Printing Greeting Cards	72
Printing on Back Print Film	75
Examples	81
Making Iron-on Transfers	82
Examples	87
Printing on Overhead Transparencies	88
Undercoating with a VPhoto Primer Ink Cartridge	92

Table of Contents

Printer Driver	96
Printer Driver Setup Dialog Box.....	97
How to Open the Printer Driver Setup Dialog Box	97
Name and Functions of Each Item of the MD-5500 Dialog Box	98
Settings in Each Tab	99
Document/Quality Tab	99
Paper Tab	104
Image Settings Tab	106

Various Printing Operations

Learning to Use the Many Functions of Your Printer

The MD-5500P not only prints outstanding monochrome and full color images but also offers a wide variety of other options, including printing in foil or metallic color and printing on iron-on transfer sheets, photo labels, and greeting cards. This chapter will show you how to use these useful functions step by step. Read Chapter 1 of this guide and learn the basic operations of your printer before reading this chapter. We hope you will take full advantage of the many functions of your printer.

Photographic-Quality Color Printing (MD-5500P)

This section describes how to print Photographic-Quality Color images on Photographic-Quality Paper. With Photographic-Quality Color printing, you can print continuous-tone images with the same high quality as photographs. In Photographic-Quality Color printing, you can also print with an overcoat ink that produces a smooth, shiny surface like a photograph.

Requirements

You need the following items for Photographic-Quality Color printing.

- **Ink cartridges**

Make sure that you use only the Photographic-Quality ink cartridges listed below.

Photo Cyan ink cartridge (Part No. 105812-00)

Photo Magenta ink cartridge (Part No. 105814-00)

Photo Yellow ink cartridge (Part No. 105816-00)

Photo Overcoat ink cartridge (Part No. 105818-00)

- **Media**

Photographic-Quality Paper (8.5" x 11") (Part No. 105822-00)

- **The guide sheet** (the thick paper with the written description) included with the set of paper sheets



Caution

Always use Photographic-Quality Paper for Photographic-Quality Color printing. Failure to do so can damage the printer as well as the cartridge ribbon. Up to 20 sheets of paper can be loaded into the sheet feeder at once.

Print surfaces that have been overcoated cannot be used for subsequent printing. If you attempt to do so, the printer may malfunction.

Step 1 ► Prepare the Image to be Printed

Use any application to create the image or document you want to print.

Step 2 ► Install the Photographic-Quality Ink Cartridges

Install the Photographic-Quality ink cartridges into the ink cartridge holders. The ink cartridges may be installed in any order.

Step 3 ► Load the Photographic-Quality Paper (8.5"x 11") in Your Printer

You may use either automatic feed mode or manual feed mode to load the paper into your printer.

1. For manual feed mode, set the paper feed switch to position "M"; for automatic feed mode, set it to "A".

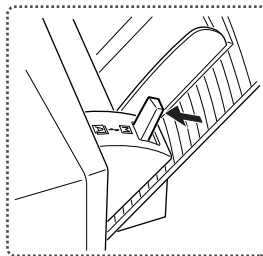

Paper feed switch "A"

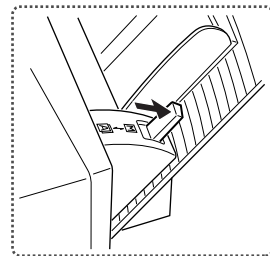

Paper feed switch "M"

2. For automatic feeding, load the guide sheet supplied with the paper into the sheet feeder, placing the printed side facing down. Then, place the Photographic-Quality Paper on this sheet. Only the glossy side of the Photographic-Quality Paper is printable, so be sure to load the sheets with the glossy, printable side up. When handling sheets, hold the bent top of the guide sheet only to avoid smearing or discoloring the glossy printing surface.

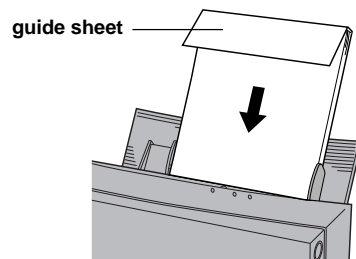

3. Adjust the paper feed guide to the width of the paper.
4. For manual feeding, load one sheet of paper in the sheet feeder, and press the *ready / insert* button.

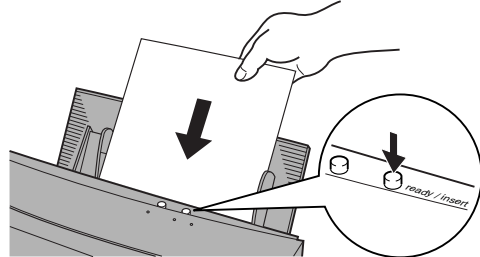

Note

Only the glossy surface of paper can be subjected to Photographic-Quality printing. Since the opposite surface cannot be printed on, make sure the paper is correctly oriented.



Important

- You may load as many as 20 sheets of Photographic-Quality Paper at one time.
- Fan the sheets before loading them on the sheet feeder. The printer may feed more than one sheet at one time when they are stuck together.
- If you do not load the guide sheet with the Photographic-Quality Paper, the final sheet may not feed properly.
- Always use the Photographic-Quality ink cartridges to print on the Photographic-Quality Paper. Printing with any other combination can damage the cartridge ribbon as well as the paper.
- Remove both the Photographic-Quality Paper and the guide sheet before loading any other type of paper.
- The guide sheet is not reusable. When you load a new set of Photographic-Quality Paper, make sure that you load them with the new guide sheet from the same package.
- Note that when all the Photographic-Quality Paper has been fed from the sheet feeder, the printer will detect that the paper feeder is empty and will not feed the guide sheet. If you try to feed the guide sheet through the printer, it may get damaged. Do not use a damaged guide sheet in the printer.
- Keep both used and unused sheets away from heat, humidity, dust, and direct sunlight.
- The printed image on the Photographic-Quality Paper may discolor. Keep it out of contact with plastic, such as document holders, wallet windows, erasers, hairdressing items, and cosmetic items.
- Keep all unused sheets in the original bag.

Step 4 ► Set Up the Printer Driver for Printing

1. Select Print from the File menu.

The following dialog box appears.

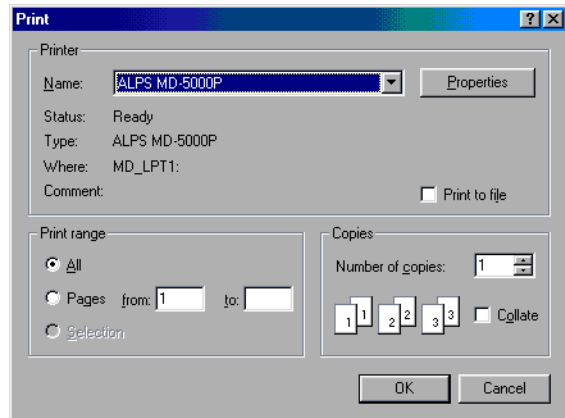
2. Click Properties.

The Document Type dialog box in the ALPS MD-5500P dialog box appears.-

Note

Please note that the procedure for opening the dialog box of ALPS MD-5500P driver may slightly differ from one application to another.

3. Select Graphics/Text or Photographs from the Document Types setting in the Document/Quality Tab.
4. Select Photographic Paper from the Media Type setting.

5. When the following notice window appears, confirm the contents, and click OK.

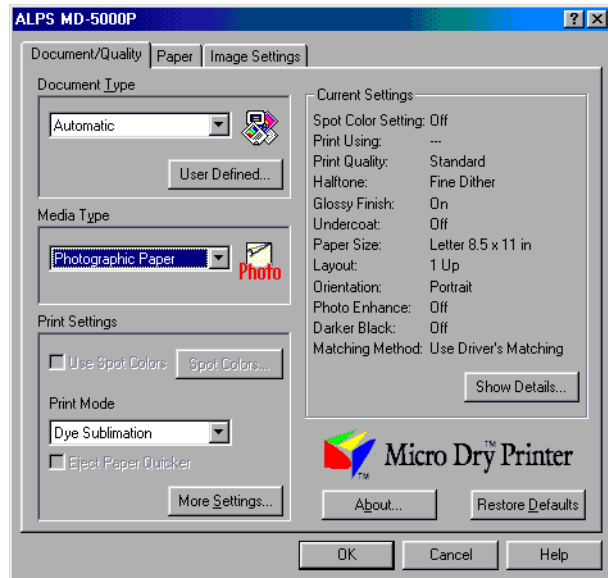

6. Change other necessary settings.
7. When you complete the setup, click OK to close the dialog box.



Note

If you select Photographic Paper from the Media Type setting, the overcoat finishing will be automatically provided. It is recommended to print with the overcoat. However, if printing with the overcoat is not desired, click the More Setting button, and then uncheck the Glossy Finish check-box in the Option setting.

Step 5 ► Print

Click OK in the Print dialog box, and printing will start.

Printing on Photographic-Quality Paper (4" x 6")

This section describes how to print Photographic-Quality Color images on Photographic-Quality Paper. With Photographic-Quality Color printing, you can print continuous-tone images with the same high quality as photographs. In Photographic-Quality Color printing, you can also print with an overcoat ink that produces a smooth, shiny surface like a photograph.

Requirements

You need the following items for Photographic-Quality Color printing.

- **Ink cartridges**

Make sure that you use only the Photographic-Quality ink cartridges listed below.

Photo Cyan ink cartridge (Part No. 105812-00)

Photo Magenta ink cartridge (Part No. 105814-00)

Photo Yellow ink cartridge (Part No. 105816-00)

Photo Overcoat ink cartridge (Part No. 105818-00)

- **Media**

Photographic-Quality Paper (4" x 6") (Part No. 105824-00)

- **The guide sheet** (the thick paper with the written description) included with the set of paper sheets



Important

Make sure that none of your Photographic-Quality Paper is warped more than 0.2" / 5 mm. Warped sheets can cause unsatisfactory print results.

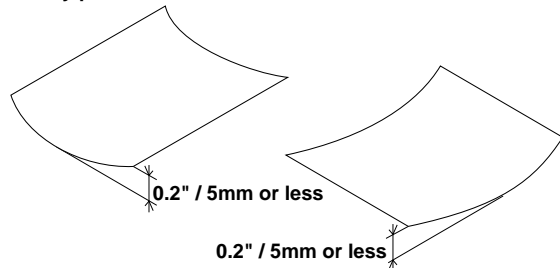

Each sheet should have a warp of 0.2" / 5 mm or less when placed on a flat surface.



Important

- Always use Photographic-Quality Paper for Photographic-Quality Color printing. Failure to do so can damage the printer as well as the cartridge ribbon. Up to 20 sheets of paper can be loaded into the sheet feeder at once.
- Print surfaces that have been overcoated cannot be used for subsequent printing. If you attempt to do so, the printer may malfunction.

Step 1 ► Prepare the Image to be Printed

Use any application to create the image or document you want to print.



Step 2 ► Install the Photographic-Quality Ink Cartridges

Install the Photographic-Quality ink cartridges into the ink cartridge holders. The ink cartridges may be installed in any order.

Step 3 ► Load the Photographic-Quality Paper (4"x 6") in Your Printer

You may use either automatic feed mode or manual feed mode to load the paper into your printer.

1. For manual feed mode, set the paper feed switch to position "M"; for automatic feed mode, set it to "A".

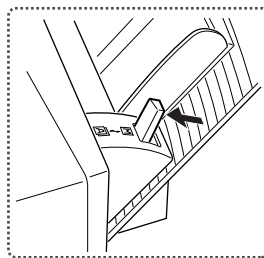

Paper feed switch "A"

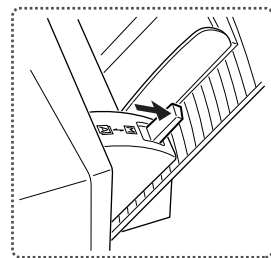

Paper feed switch "M"

2. For automatic feeding, load the guide sheet supplied with the paper into the sheet feeder, placing the printed side facing down. Then, place the Photographic-Quality Paper on the guide sheet. Only the glossy side of the Photographic-Quality Paper is printable, so be sure to load the sheets with the glossy, printable side up. When handling sheets, hold the bent top of the guide sheet only to avoid smearing or discoloring the glossy printing surface.

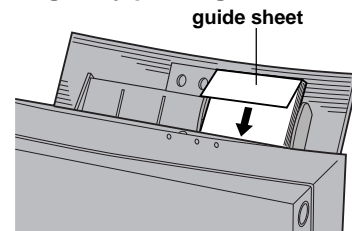

3. Adjust the paper feed guide to the width of the paper.

4. For manual feeding, load one sheet of paper in the sheet feeder, and press the *ready / insert* button.

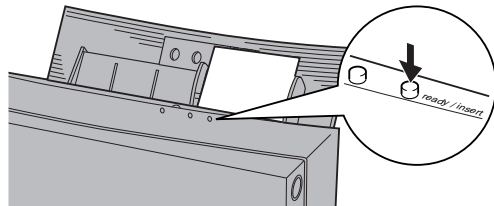

Note

Only the glossy surface of paper can be subjected to Photographic-Quality printing. Since the opposite surface cannot be printed on, make sure the paper is correctly oriented.



Important

- You may load as many as 20 sheets of Photographic-Quality Paper at one time.
- Fan the sheets before loading them on the sheet feeder. The printer may feed more than one sheet at one time when they are stuck together.
- If you do not load the guide sheet with the Photographic-Quality Paper, the final sheet may not feed properly.
- Always use the Photographic-Quality ink cartridges to print on the Photographic-Quality Paper. Printing with any other combination can damage the cartridge ribbon as well as the paper.
- Remove both the Photographic-Quality Paper and the guide sheet before loading any other type of paper.
- The guide sheet is not reusable. When you load a new set of Photographic-Quality Paper, make sure that you load them with the new guide sheet from the same package.
- Note that when all the Photographic-Quality Paper has been fed from the sheet feeder, the printer will detect that the paper feeder is empty and will not feed the guide sheet. If you try to feed the guide sheet through the printer, it may get damaged. Do not use a damaged guide sheet in the printer.

- Keep both used and unused sheets away from heat, humidity, dust, and direct sunlight.
- A printed image on Photographic-Quality Paper may discolor. Keep it out of contact with plastic, such as document holders, wallet windows, erasers, hairdressing items, and cosmetic items.
- Keep all unused sheets in the original bag.

Step 4 ► Set Up the Printer Driver for Printing

1. Select Print from the File menu.

The following dialog box appears.

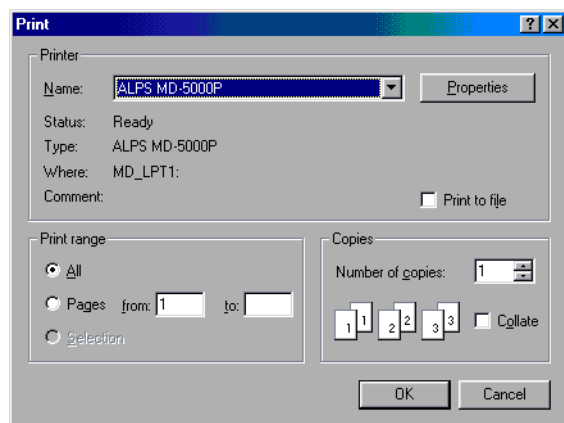

2. Click Properties.

The Document Type dialog box in the ALPS MD-5500P dialog box appears.



Important

Please note that the procedure for opening the dialog box of ALPS MD-5500P driver may slightly differ from one application to another.

3. Select Graphics/Text, or Photographs from the Document Types setting in the Document/Quality Tab.

4. Select Photographic Paper from the Media Type setting.

5. When the following notice window appears, confirm the contents and click OK.

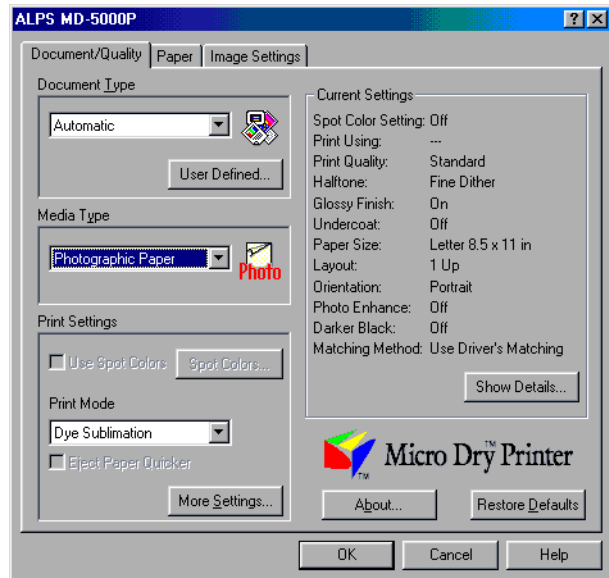

6. Select Photo Paper 4 x 6 in from the Paper Size setting in the Paper Tab.

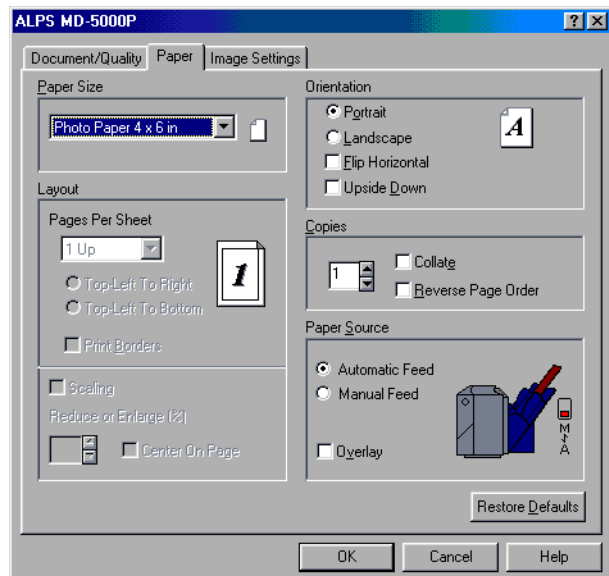

-
7. **Change other necessary settings.**

 8. **When you complete the setup, click OK to close the dialog box.**

**Note**

If you select Photographic Paper from the Media Type setting, the overcoat finishing will be automatically provided. It is recommended to print with the overcoat. However, if printing with the overcoat is not desired, click the More Setting button, and then uncheck the Glossy Finish check-box in the Option setting.

Step 5 ► Print

Click OK in the Print dialog box and printing will start.

Printing on Photographic-Quality Labels

This section describes how to print Photographic Quality Color images on Photographic-Quality Labels. The Photographic-Quality Labels are available in the following two types.

Photographic-Quality Labels (20 stickers) (Part No. 105850-00) **Photographic-Quality Labels (2 stickers) (Part No. 105848-00)**

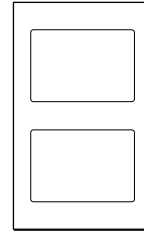
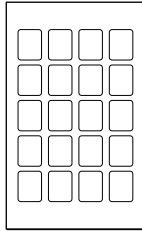

Photographic-Quality Labels may be used with a variety of items, such as business cards, greeting cards and name tags.

Requirements

You need the following items for printing on the Photographic-Quality Labels.

- **Ink cartridges**

Make sure that you use only the Photographic-Quality ink cartridges listed below.

Photo Cyan ink cartridge (Part No. 105812-00)

Photo Magenta ink cartridge (Part No. 105814-00)

Photo Yellow ink cartridge (Part No. 105816-00)

Photo Overcoat ink cartridge (Part No. 105818-00)

- **Media**

Photographic-Quality Labels (2 stickers) (Part No. 105848-00)

or

Photographic-Quality Labels (20 stickers) (Part No. 105850-00)

- **The guide sheet** (the thick paper with the written description) included with the set of paper sheets



Important

- Always use the above listed ALPS Photographic-Quality Labels. Using some other types of paper can cause the printer to malfunction.
- Print surfaces that have been overcoated cannot be used for subsequent printing. If you attempt to do so, the printer may malfunction.

Step 1 ► Create Data for Printing on Photographic-Quality Labels

Use the application of your choice to create the text and graphics you want, and lay them out within the printable area of a Photographic-Quality Label.

The following explanation will assume the use of Photographic-Quality Labels (2 stickers). Follow the same general sequence when you use Photographic-Quality Labels (20 stickers).

Photographic-Quality Labels templates have been prepared in the Label folder of the ALPS Installation CD-ROM included in the package. When creating data using those templates, please see the section "How to Use Templates" on the ALPS Installation CD-ROM for instructions. You may use them, or employ some other application to lay out the data according to the print format shown below.

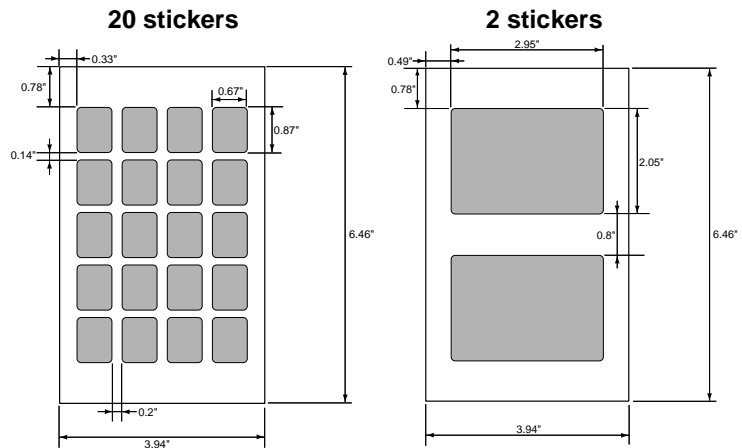

Step 2 ► Install the Photographic-Quality Ink Cartridges

Install the Photographic-Quality ink cartridges into the ink cartridge holders. The ink cartridges may be installed in any order.

Step 3 ► Load the Photographic-Quality Labels in Your Printer

You may use either automatic feed mode or manual feed mode to load the paper into your printer.

1. For manual feed mode, set the paper feed switch to position "M"; for automatic feed mode, set it to "A".

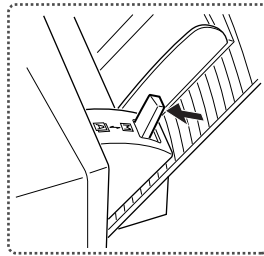

Paper feed switch "A"

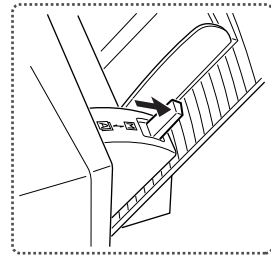

Paper feed switch "M"

2. For automatic feeding, load the guide sheet supplied with the paper into the sheet feeder, placing the printed side facing down. Then, place the Photographic-Quality Labels on the guide sheet. Only the glossy side of the Photographic-Quality Labels is printable, so be sure to load the sheets with the glossy, printable side up. When handling sheets, hold the bent top of the guide sheet only to avoid smearing or discoloring the glossy printing surface.

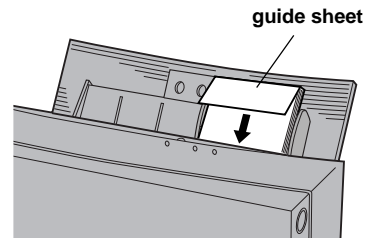

3. Adjust the paper feed guide to the width of the paper.
4. For manual feeding, load one sheet of paper in the sheet feeder, and press the *ready / insert* button.

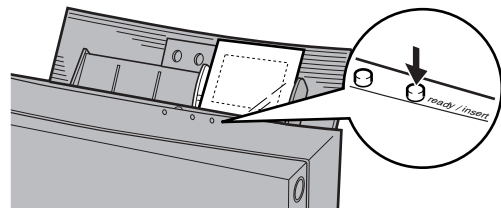

Note

Only the glossy surface of paper can be subjected to Photographic-Quality printing. Since the opposite surface cannot be printed on, make sure the paper is correctly orientated.



Important

- You may load as many as 20 sheets of Photographic-Quality Labels at one time.
- Fan the sheets before loading them on the sheet feeder. The printer may feed more than one sheet at one time when they are stuck together.
- If you do not load the guide sheet with the Photographic-Quality Labels, the final sheet may not feed properly.
- Always use the Photographic-Quality ink cartridges to print on the Photographic-Quality Labels. Printing with any other combination can damage the cartridge ribbon as well as the paper.
- Remove both the Photographic-Quality Labels and the guide sheet before loading any other type of paper.
- The guide sheet is not reusable. When you load a new set of Photographic-Quality Labels, make sure that you load them with the new guide sheet from the same package.
- Note that when all the Photographic-Quality Labels have been fed from the sheet feeder, the printer will detect that the paper feeder is empty and will not feed the guide sheet. If you try to feed the guide sheet through the printer, it may get damaged. Do not use a damaged guide sheet in the printer.
- Keep both used and unused sheets away from heat, humidity, dust, and direct sunlight.
- The printed image on Photographic-Quality Labels may discolor. Keep it out of contact with plastic, such as document holders, wallet windows, erasers, hairdressing items, and cosmetic items.
- Keep all unused sheets in the original bag.

Step 4 ► Set Up the Printer Driver for Printing

1. Select Print from the File menu.

The following dialog box appears.

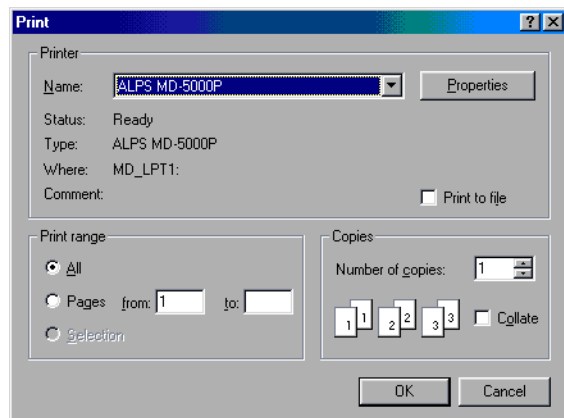

2. Click Properties.

The Document Type dialog box in the ALPS MD-5500P dialog box appears.

Important

Please note that the procedure for opening the dialog box of ALPS MD-5500P driver may slightly differ from one application to another.

3. Select Graphics/Text, or Photographs from the Document Types setting in the Document/Quality Tab.

4. Select Photographic Label from the Media Type setting.

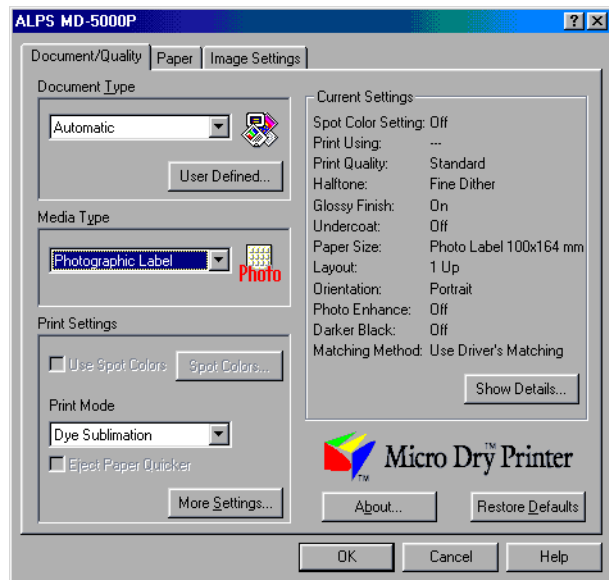
5. When the following notice window appears, confirm the contents and click OK.

6. Change other necessary settings.

-
7. When you complete the setup, click OK to close the dialog box.

**Note**

If you select Photographic Label from the Media Type setting, the overcoat finishing will be automatically provided. It is recommended to print with the overcoat. However, if printing with the overcoat is not desired, click the More Setting button, and then uncheck the Glossy Finish check-box in the Option setting.

Step 5 ► Print

Click OK in the Print dialog box, and printing will start.

VPhoto Color Printing on VPhoto Print Film

This section describes how to print images on Vphoto print film. Photogravure-like quality can be achieved by printing images on VPhoto print film with Micro Dry™ standard inks. This is very effective when printing multicolored images like computer graphics (CG).

Requirements

You need the following items for VPhoto Color printing.

- **Media**

VPhoto Print Film (8.5" x 11") (Part No. 105829-00)

- **Ink Cartridges**

Cyan ink cartridge (Part No. 106020-00)

Magenta ink cartridge (Part No. 106015-00)

Yellow ink cartridge (Part No. 106010-00)

Black ink cartridge (Part No. 106005-00)

Finish II ink cartridge (Part No. 105144-00)



Caution

VPhoto Print Film is very adhesive. When loading the multiple sheets, fan them thoroughly before loading to make sure that they do not adhere to one another. Keep unused sheets in the package for storage.

For best results, use single sheet and manual feed.

Step 1 ► Prepare the Image to Be Printed

Create the image or document you want to print by arranging texts, graphic objects, photographs, etc. with any application.

Step 2 ► Install the Ink Cartridges

Install the total of five ink cartridges (cyan, magenta, yellow, black, and finish II) into the ink cartridge holders. The ink cartridges may be installed in any order.

For details, please refer to the section entitled "Installing Ink Cartridges" in Chapter 1.

Step 3 ► Load the VPhoto Print Film (8.5" x 11") in Your Printer

You may use either automatic feed mode or manual feed mode to load the film into your printer.

1. For manual feed mode, set the paper feed switch to position "M"; for automatic feed mode, set it to "A".
2. Adjust the paper feed guide to the width of the paper.
3. For automatic feeding, extend the paper support for two clicks, then load only one sheet.



Note

VPhoto Print Film is very adhesive. When loading the multiple sheets, fan them thoroughly before loading to make sure that they do not adhere to one another. Keep unused sheets in the package for storage.

For best results, use single sheet and manual feed.

4. For manual feeding, load one sheet of VPhoto Print Film in the sheet feeder, and press the *ready/insert* button.

Step 4 ► Set Up the Printer Driver for Printing

1. Select Print from the File menu to open the Print dialog box, then click Properties.

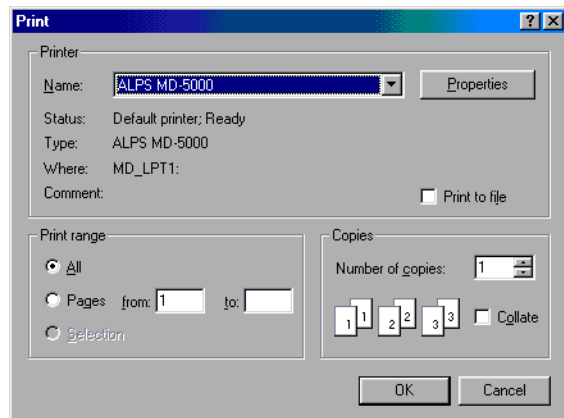

2. Click the Document/Quality tab to bring this portion to the front.
3. Select Automatic, Photographs, or Graphics/Text from the Document Type depending on the document to be printed.
4. Select VPhoto Print Film from the Media Type setting.

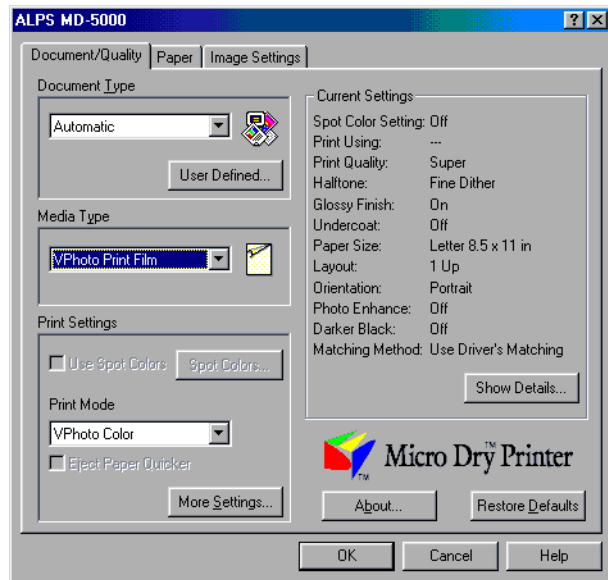

5. Change the necessary settings.
6. When you complete the setup, click OK to close the dialog box.

**Note**

When VPhoto Print Film is selected from the Media Type, Glossy Finish is automatically set. We recommend that glossy finish be normally provided. If you do not want to obtain glossy finish, click the More Settings button, then uncheck the Glossy Finish check box in the More Settings dialog box.

Step 5 ► Print

Click OK in the Print dialog box to start printing.

VPhoto Color Printing on VPhoto Paper

This section describes how to print images on VPhoto Paper. Photogravure-like quality can be achieved by printing images on VPhoto Paper with Micro Dry™ standard inks. This is very effective when printing multicolored images like computer graphics (CG).

Requirement

You need the following items for Vphoto Color printing.

- **Media**

VPhoto Paper (4x6" Plus) (Part No. 105831-00)



Important

Make sure that none of your Vphoto Paper is warped more than 0.2"/5 mm. Warped sheets can cause unsatisfactory print results.

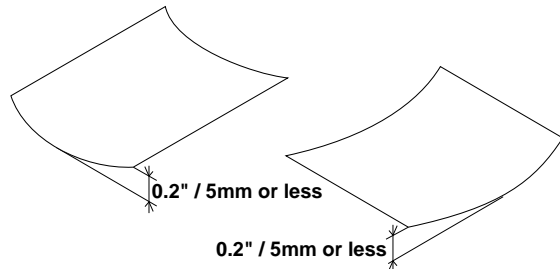

Each sheet should have a warp of 0.2" or less when placed on a flat surface.

- **Ink Cartridges**

Cyan ink cartridge (Part No. 106020-00)

Magenta ink cartridge (Part No. 106015-00)

Yellow ink cartridge (Part No. 106010-00)

Black ink cartridge (Part No. 106005-00)

Finish II ink cartridge (Part No. 105144-00)

Step 1 ► Prepare the Image to Be Printed

Create the image or document you want to print by arranging texts, graphic objects, photographs, etc. with any application.

Step 2 ► Install the Ink Cartridges

Install the total of five ink cartridges (cyan, magenta, yellow, black, and finish II) into the ink cartridge holders. The ink cartridges may be installed in any order.

For details, please refer to the section entitled “Installing Ink Cartridges” in Chapter 1.

Step 3 ► Load the VPhoto Paper (4x6" Plus) in Your Printer

1. For both manual and automatic feed modes, set the paper feed switch to position “M”.

2. For continuous printing in the automatic feed mode, use the paper stopper.



Note

- You may load as many as 20 sheets of VPhoto Paper (4x6" Plus) at one time.
- Fan the sheets before loading them in the sheet feeder. The printer may feed more than one sheet at one time when the VPhoto Paper are stuck together.

3. For manual feeding, load one sheet of VPhoto Paper (4x6" Plus) in the sheet feeder, and press the *ready/insert* button.

Step 4 ► Set Up the Printer Driver for Printing

1. Select Print from the File menu to open the Print dialog box, then click Properties.

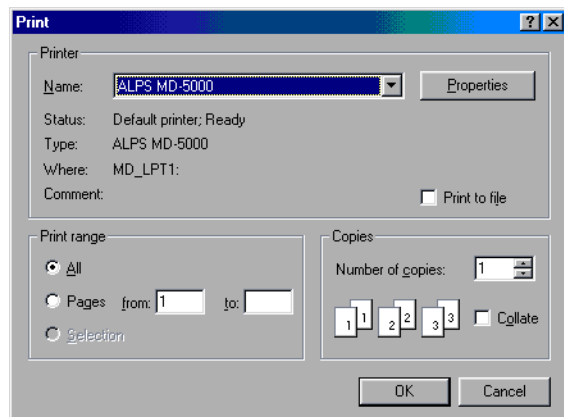

2. Click the Document/Quality tab to bring this portion to the front.
3. Select Automatic, Photographs, or Graphics/Text from the Document Type depending on the document to be printed.
4. Select VPhoto Paper (4x6" Plus) from the Media Type setting.

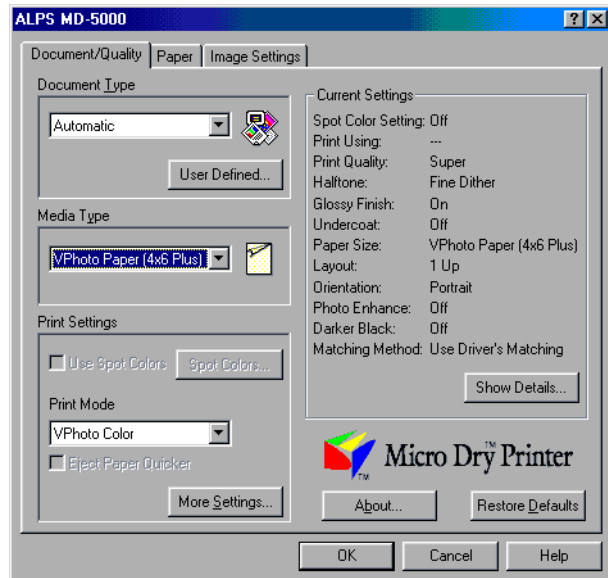

5. Change the necessary settings.
6. When you complete the setup, click OK to close the dialog box.



Note

When VPhoto Paper (4x6" Plus) is selected from the Media Type, Glossy Finish is automatically set. We recommend that glossy finish be normally provided. If you do not want to obtain glossy finish, click the More Settings button, then uncheck the Glossy Finish check box in the More Settings dialog box.

Step 5 ► Print

Click OK in the Print dialog box to start printing.

VPhoto Color Printing on Plain Paper

This section describes how to print VPhoto color images on plain paper. Photogravure-like quality can be achieved by printing VPhoto color images on plain paper. This is very effective when printing multi-colored images like computer graphics (CG).

Requirement

You need the following items for VPhoto Color printing.

- **Media**

High Grade Paper (Part No. 106085-00) or Plain Paper

- **Ink Cartridges**

Cyan ink cartridge (Part No. 106020-00)

Magenta ink cartridge (Part No. 106015-00)

Yellow ink cartridge (Part No. 106010-00)

Black ink cartridge (Part No. 106005-00)

Finish II ink cartridge (Part No. 105144-00)

VPhoto Primer ink cartridge (Part No. 105142-00)



Note

VPhoto Primer ink fills unevenness of the paper surface, so that the similar print quality as printing on VPhoto Print Film can be achieved. To print the Photo Quality images on plain paper, use VPhoto Primer ink.

Step 1 ► Prepare the Image to Be Printed

Create the image or document you want to print by arranging texts, graphic objects, photographs, etc. with any application.

Step 2 ► Install the Ink Cartridges

Install the necessary ink cartridges into the ink cartridge holders. The ink cartridges may be installed in any order.

For details, please refer to the section entitled 'Installing Ink Cartridges' in Chapter 1.

Step 3 ► Load the Paper in Your Printer

You may use either automatic feed mode or manual feed mode to load the paper into your printer.

1. **For manual feed mode, set the paper feed switch to position “M”; for automatic feed mode, set it to “A”.**
2. **Adjust the paper feed guide to the width of the paper.**
3. **For automatic feeding, fully extend the paper support.**
4. **For automatic feeding, load two or more sheets in the sheet feeder.**
5. **For manual feeding, load one sheet of paper in the sheet feeder, and press the ready/insert button.**

Step 4 ► Set Up the Printer Driver for Printing

1. **Select Print from the File menu to open the Print dialog box, then click Properties.**

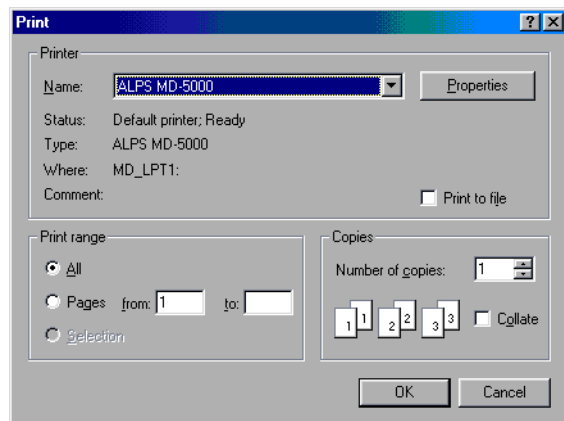

2. **Click the Document/Quality tab to bring this portion to the front.**
3. **Select Automatic, Photographs, or Graphics/Text from the Document Type depending on the document to be printed.**
4. **Select Plain Paper for plain paper, and Laser Paper for High Grade Paper from the Media Type setting.**

5. Set Print Mode to VPhoto Color.

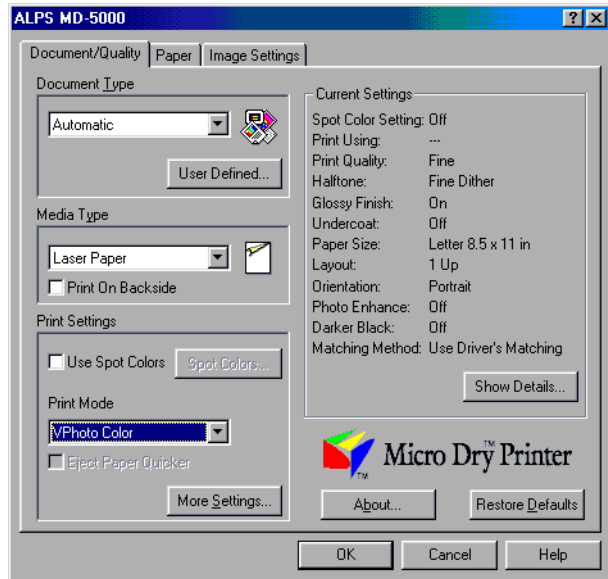

Note

- When Laser Paper and VPhoto Color are selected from the Media Type and Print Mode, respectively, Glossy Finish is automatically set. We recommend that glossy finish be normally provided. If you do not want to obtain glossy finish, click the More Settings button, then uncheck the Glossy Finish check box in the More Settings dialog box.
- When Plain Paper and VPhoto Color are selected from the Media Type and Print Mode, respectively, VPhoto Premier (Undercoat) and Glossy Finish are automatically set. (VPhoto Premier (Undercoat) is set when Automatic, Photographs, or Graphics/Text is selected from Document Type.) We recommend that glossy finish be normally provided. If you do not want to obtain glossy finish, click the More Settings button, then uncheck the Glossy Finish check box in the More Settings dialog box.

6. Change the necessary settings.

7. When you complete the setup, click OK to close the dialog box.

Step 5 ► Print

Click OK in the Print dialog box to start printing.

VPhoto Color Printing on Photo Realistic Labels

This section describes how to print VPhoto Color images on Photo Realistic Labels. Photo Realistic Labels may be used as photo stickers. Prepare the image you want to print using a scanner or a digital camera, then layout it out within the printable area of a Photo Realistic Label.

Requirement

You need the following items for printing on Photo Realistic Labels.

- **Media**

Photo Realistic Labels (7/8" x 5/8") (Part No. 105108-00)

- **Ink Cartridges**

The following ink cartridges may be used.

Cyan ink cartridge (Part No. 106020-00)

Magenta ink cartridge (Part No. 106015-00)

Yellow ink cartridge (Part No. 106010-00)

Black ink cartridge (Part No. 106005-00)

Finish II ink cartridge (Part No. 105144-00)

Step 1 ► Prepare the Image to Be Printed

Create the image you want to print by arranging photographs, pictures, etc. with any application.

Step 2 ► Install the Ink Cartridges

Install the cyan, magenta, yellow, black, and finish II ink cartridges into the ink cartridge holders. The ink cartridges may be installed in any order.

For details, please refer to the section entitled 'Installing Ink Cartridges' in Chapter 1.

Step 3 ► Load the Paper in Your Printer

Manual feed mode is used for this printing.

1. **Set the paper feed switch to position 'M'.**
2. **Adjust the paper feed guide to the width of the paper plus several millimeters.**

3. Load one sheet of Photo Realistic Label in the sheet feeder, and press the *ready/insert* button.



Note

- Be sure to manually feed Photo Realistic Labels one at a time.
- For Photo Realistic Labels, load so that the glossy surface faces upward.
- Provide a gap of several millimeters between the paper feed guide and Photo Realistic Labels. Otherwise, paper may not feed correctly.

Step 4 ► Set Up the Printer Driver for Printing

1. Select Print from the File menu to open the Print dialog box, then click Properties.

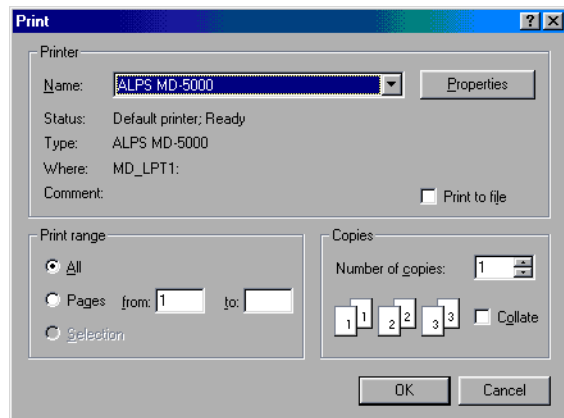

2. Click the Document/Quality tab to bring this portion to the front.
3. Select Automatic, Photographs, or Graphics/Text from the Document Type depending on the document to be printed.
4. Select Photo Realistic Label from the Media Type setting.

**Note**

When Photo Realistic Label is selected from the Media Type, Print Mode is automatically set to VPhoto Color. And Glossy Finish is also automatically set. We recommend that glossy finish be normally provided. If you do not want to obtain glossy finish, click the More Settings button, then uncheck the Glossy Finish check box in the More Settings dialog box.

-
5. **Change the necessary settings.**
 6. **When you complete the setup, click OK to close the dialog box.**

Step 5 ► Print

Click OK in the Print dialog box to start printing.

Full Color & Photo Realistic Finishing (Glossy Finish)

Use the steps outlined here for full color printing and photo realistic finishing (glossy finish). Then the image will be finished with a Finish II cartridge, to create a glossy effect similar to a Photograph. This method is particularly effective for printing photographic images.

Requirements

For full color printing + photo realistic finishing, you need the following items.

- **Ink cartridge**

Cyan ink cartridge (Part No. 106020-00)
 Magenta ink cartridge (Part No.106015-00)
 Yellow ink cartridge (Part No.106010-00)
 Black ink cartridge (Part No. 106005-00)
 Finish II ink cartridge (Part No. 105144-00)

- **Media**

High Grade Paper (Letter)(Part No. 106085-00)
 Greeting Card Set (Part No. 106090-00)



Note

When printing 600 x 600 dpi full color + photo realistic finishing, we suggest using High Grade Paper or a Greeting Card Set to obtain the best results.



Note

- A good finish cannot be obtained if glossy finish is provided to plain paper that lacks a smooth surface.
- The Finish II ink cartridge is reversible up to five times. If glossy finish is provided to plain paper of which surface is not smooth, color ink might be attached to the finish II ink cartridge. If the finish II ink cartridge is reversed and used in this situation, the paper surface to which glossy finish is provided could be ink stained. When using the Finish II ink cartridge after reversing it, the following conditions should be met:
 1. Provide glossy finish to either VPhoto Print Film (8.5" x 11") or VPhoto Paper (4x 6" Plus).
 2. Provide glossy finish to ALPS High Grade Paper.

Printing Method

For printing in 600 x 600 dpi full color + glossy finish, select Automatic, Graphics/

Text or Photographs from the Document Type setting in the Document/Quality Tab in the MD-5500 printer driver dialog box. Then select Glossy Finish from the Print Mode setting tab.

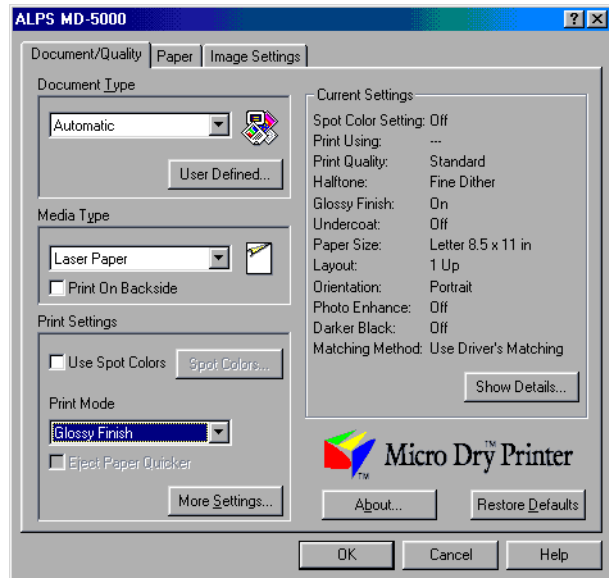

Printing is carried out in the following order: cyan, magenta, yellow, black and finishing. For details, see the instructions for the specific type of print paper.

Printing in Spot Color

Spot color printing is a unique feature of the MD-Series printers. Although most applications are not designed to handle spot color printing, the MD-5500 printer driver allows you to select specific colors or color components that will be replaced by spot colors such as metallic and white inks when printing. You can print with up to five spot colors (or five spot colors plus black) from most applications that allow color specification.

Moreover, because metallic inks are opaque, metallic printing is unaffected by the color of the underlying paper. As a result, you can print not only on colored paper but also on black glossy surfaces or brightly colored surfaces (like those found in greeting cards).

When a white ink is used as undercoat, colored paper can be subjected to full color printing. To provide a white undercoat, see "Undercoating with the White Ink Cartridge".

Types of Spot Color Printing

The following types of spot color printing are possible depending on the types of ink cartridges used.

- **Single Ink**
Spot color printing using a single color.
- **Multiple Inks**
Spot color printing using 2 or more colors. Up to 3 spot colors plus black can be used.
- **Metallic & CMYK Inks**
Full color printing and spot color printing can be combined in two ways, by printing in Overlay mode or by printing all colors in one sequence.

Single Ink Printing

Single Ink printing uses just one color. Only the color to be used is installed in the printer. This method is used when an entire image or document is going to be printed in a single color.

This method of printing can be used even when the application you are using does not allow designation of color compositions. Using this method, even full color or grayscale images can be printed in spot color.

Requirements

For single spot color printing you will need the following.

- **Ink cartridges**

For spot ink printing at least one ink cartridge is required.

Metallic gold ink cartridge (Part No. 106030-00)

Metallic silver ink cartridge (Part No. 106045-00)

Metallic magenta ink cartridge (Part No. 106035-00)

Metallic cyan ink cartridge (Part No. 106040-00)

White ink cartridge (Part No. 106050-00)

Cyan ink cartridge (Part No. 106020-00)

Magenta ink cartridge (Part No.106015-00)

Yellow ink cartridge (Part No.106010-00)

Black ink cartridge (Part No. 106005-00)

- **Media**

Plain or smooth paper can be used just as with normal color printing.

Since metallic ink is not transparent, printing on colored paper also works well. We suggest using High Grade Paper (Part No. 106085-00) and Greeting Cards (Part No. 106090-00).

White ink can be printed on iron-on transfer sheets, overhead projector transparencies, or back print films.

Step 1 ► Create Data for Spot Color Printing

Use any application to create the image or document you want to print, and prepare it just as you would for normal printing.



Note

It is not necessary to select a color in the application that matches the color of the ink cartridge in the printer. Leaving the characters and images in black is fine. Color and shaded areas will be printed in varying gradations as dot matrices under the Grayscale setting.

Step 2 ► Install the Ink Cartridge

Install the metallic ink cartridge you want to print with in cartridge holder.

Step 3 ► Load Paper

The method used for loading paper depends on the paper type. Use manual feed mode for thick paper and greeting cards. For plain paper, laser paper, and High Grade Paper, you may also use automatic feed mode to print a number of sheets at one time. For details, see the section entitled 'Loading Paper' in Chapter 1.

1. For manual feed mode, set the paper feed switch to position "M"; for automatic feed mode, set it to "A".

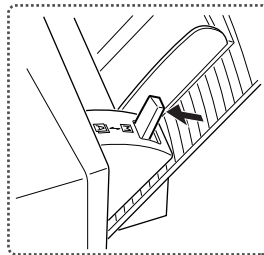

Paper feed switch 'A'

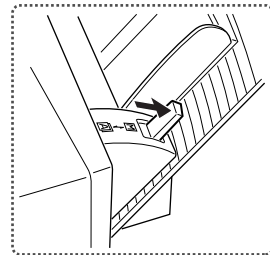

Paper feed switch 'M'

2. For Letter / A4 paper, fully extend the paper support.

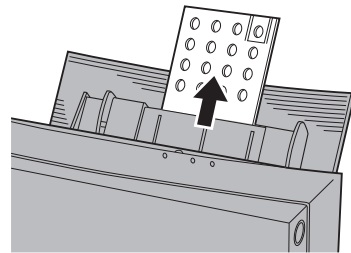

3. Adjust the paper feed guide to the width of the paper.

4. For manual feeding, load one sheet of paper into the sheet feeder and press the *ready/insert* button. For automatic feeding, load all of the sheets together.

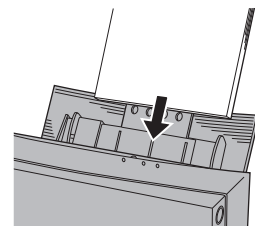

Manual feeding

Automatic feeding

Step 4 ► Set Up the Printer Driver for Printing

1. Select Print from the File menu to open the Print dialog box, then click Properties.

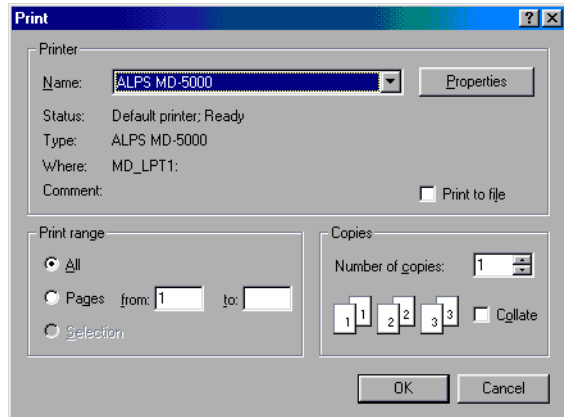

2. Click the Document/Quality tab to bring this portion to the front.
3. Set Document Type to an option appropriate to the document to be printed.
4. Set Media Type depending on the paper used.

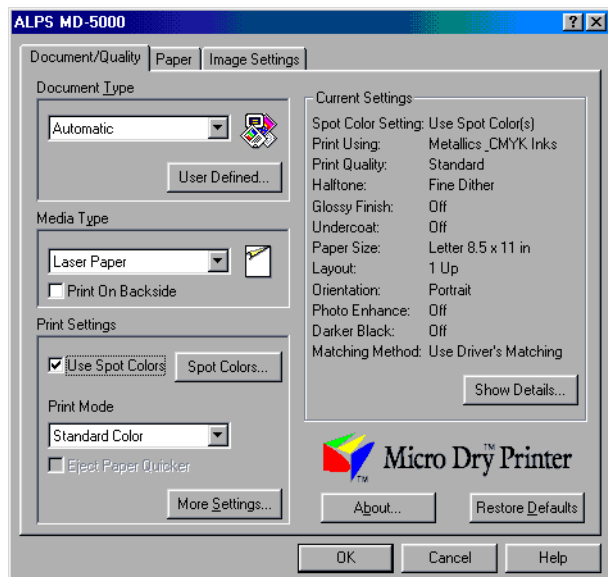

5. Check Use Spot Colors check box so that the Spot Colors dialog box is displayed.
6. Click the Use Spot Color(s) radio button.
7. Set Print Using to Single Ink.
8. Enabled ink cartridges among those installed in the printer are displayed in Select Ink Cartridge(s). Click the radio button(s) of the ink cartridge(s) to be used.

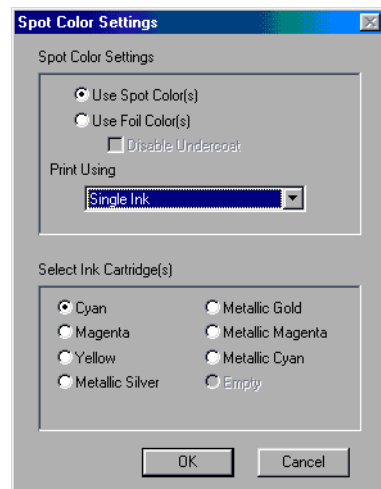
**Caution**

If bidirectional communication is not possible, all the usable ink cartridges are displayed.

9. When you complete the setup, click OK to close the dialog box.

Step 5 ► Print

Click OK in the Print dialog box to start printing.

Multiple Inks Printing

Use the steps outlined here for spot color printing using two or more spot color ink cartridges. By associating each spot color with a color (or color composition) in your application, you can print with as many as six spot colors (or five spot colors and black). You can use this method with most applications that support color.

Requirements

For multi spot color printing you will need the following.

- **Ink cartridges**

When printing with multiple spot color inks as many as four of the following ink cartridges can be used.

Metallic gold ink cartridge (Part No. 106030-00)

Metallic silver ink cartridge (Part No. 106045-00)

Metallic magenta ink cartridge (Part No. 106035-00)

Metallic cyan ink cartridge (Part No. 106040-00)

Black ink cartridge (Part No. 106005-00)

White ink cartridge (Part No. 106050-00)

- **Media**

Plain or smooth paper can be used just as with normal color printing.

Since metallic ink is not transparent, printing on colored paper also works well. We suggest using High Grade Paper (Letter) (Part No. 106085-0) and Greeting Cards (Part No. 106090-00).

Step 1 ► Create Data for Spot Color Printing

1. Use any application to create the image or document you want to print, and prepare it just as you would for normal printing. The image may contain text as well as graphics.

**Note**

Single spot color printing can produce grayscale images. However, be aware that intermediate gradations are not possible when using more than one spot color at a time.

**Note**

Full color or grayscale images with gradations can be converted to graded black and white images using photo retouch software. In this way, full color and grayscale images can be printed with gradations to some degree.

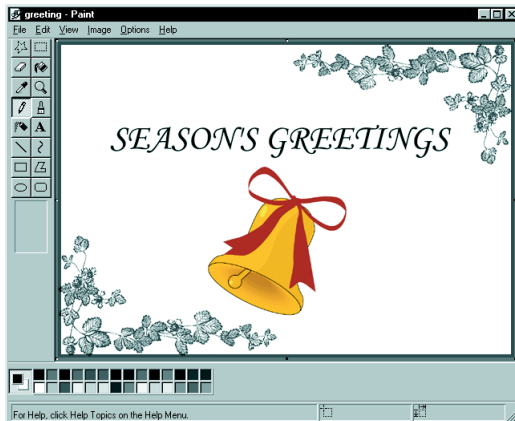

2. Set the colors corresponding to each spot color you want to use.

For example, set the parts of the image that you want to print in metallic gold to yellow, the parts of the image that you want to print metallic cyan to blue, and so forth. If you are also using black, set the parts of the image that you want to print in black to black.

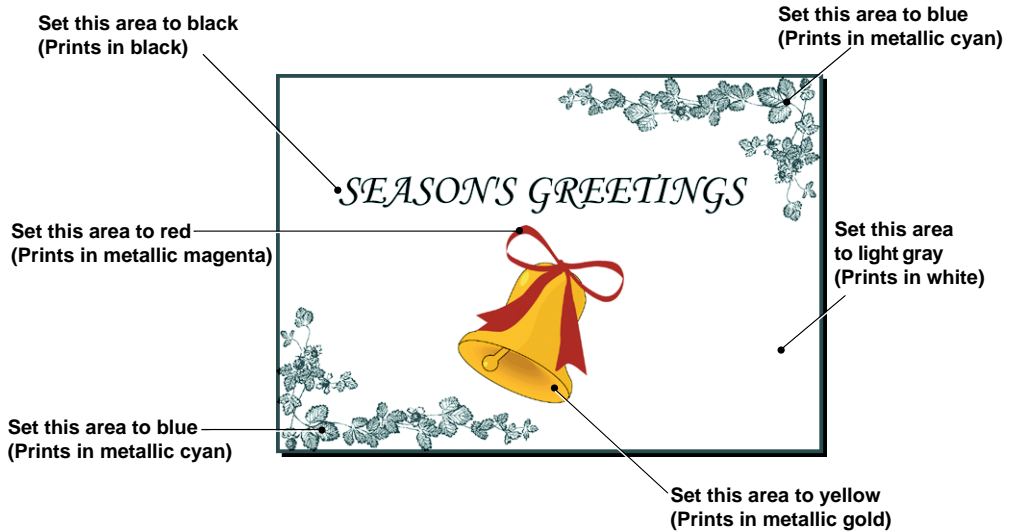

Note

Many applications have color palettes that allow easy selection of metallic colors.

The colors (and color compositions) associated with spot colors are shown in the following table.

■ Colors (and color compositions) used to indicate spot colors

In multi spot color printing, indicate spot colors by selecting colors in the application that resemble the spot colors.

As much as possible, try to select colors that resemble the spot colors to be printed. In applications that do not have many color choices, such as word processors, closely related colors can be used. In this case, however, check the color output by executing a test print to make sure the correct spot colors are printed.

Spot color	Application color used to indicate the spot color
Metallic Gold	Yellow (or yellow-orange)
Metallic Silver	Gray
Metallic Magenta	Magenta, Red (a red close to magenta)
Metallic Cyan	Cyan, Blue (a blue close to cyan)
White	Light gray (a gray close to white)
(Normal) Black	Normal black (R=G=B=0 or C=M=Y=0, K=100)

The following table indicates the color compositions settings that will most closely resemble the printed results. In applications that allow the user to make color composition settings, adjust the settings as shown below.

■ Tables of color composition settings for spot color printing

- Color compositions using RGB settings (n/255)

Spot color	R	G	B
Metallic Gold	225	160	0
Metallic Silver	189	193	197
Metallic Magenta	163	36	115
Metallic Cyan	0	176	201
White	230	230	230

- Color compositions using RGB settings (n/100%)

Spot color	R	G	B
Metallic Gold	88	63	0
Metallic Silver	74	76	77
Metallic Magenta	64	14	45
Metallic Cyan	0	69	79
White	98	98	98

- Color compositions using CMYK settings (n/100%)

Spot color	C	M	Y	K
Metallic Gold	12	37	100	0
Metallic Silver	26	24	23	0
Metallic Magenta	36	86	55	0
Metallic Cyan	100	31	21	0
White	2	2	2	0



Note

For instructions on changing color composition settings in an application, refer to the manual that came with your application. Depending on the application, a spot color may not print correctly even though the color settings were properly set in the application.

Step 2 ► Install the Spot Ink Cartridges

Install all the spot ink cartridges for the spot colors you want to use into the ink cartridge holders. The order of the ink cartridges is not important.

Step 3 ► Load Paper in Your Printer

The method used for loading paper depends on the paper type. Use manual feed mode for thick paper and greeting cards. For plain paper, laser paper, and High Grade Paper, you may also use automatic feed mode to print a number of sheets at one time. For details, see the section entitled "Loading Paper" in Chapter 1.

1. For manual feed mode, set the paper feed switch to position "M"; for automatic feed mode, set it to "A".

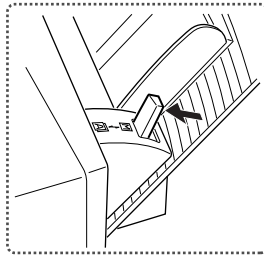

Paper feed switch 'A'

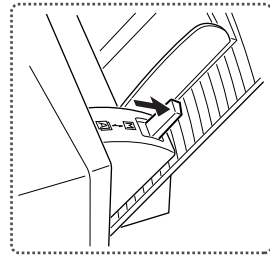

Paper feed switch 'M'

2. For Letter / A4 paper, fully extend the paper support.

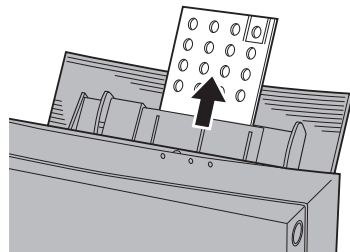

3. Adjust the paper feed guide to the width of the paper.

4. For manual feeding, load one sheet of paper into the sheet feeder and press the *ready / insert* button. For automatic feeding, load all of the sheets together.

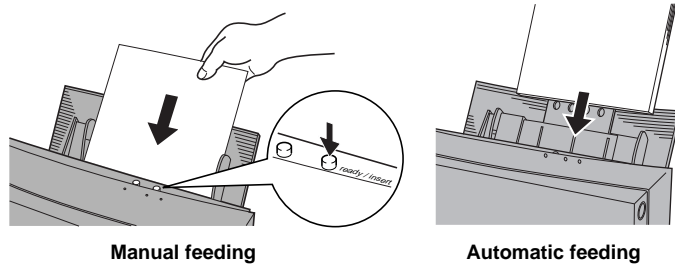

Step 4 ► Set Up the Printer Driver for Printing

1. Select Print from the File menu to open the Print dialog box, then click Properties.

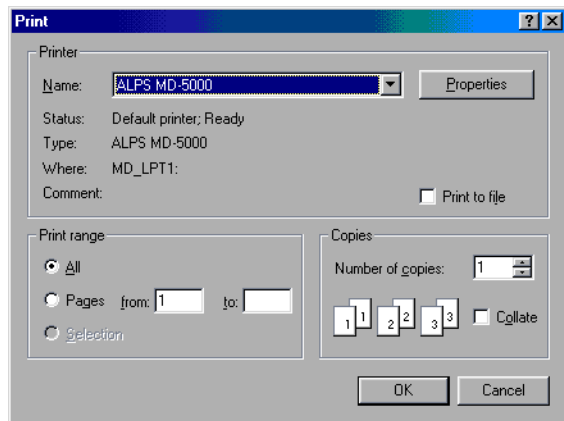

2. Click the Document/Quality tab to bring this portion to the front.
3. Set Document Type to an option appropriate to the document to be printed.

4. Set Media Type depending on the paper used.

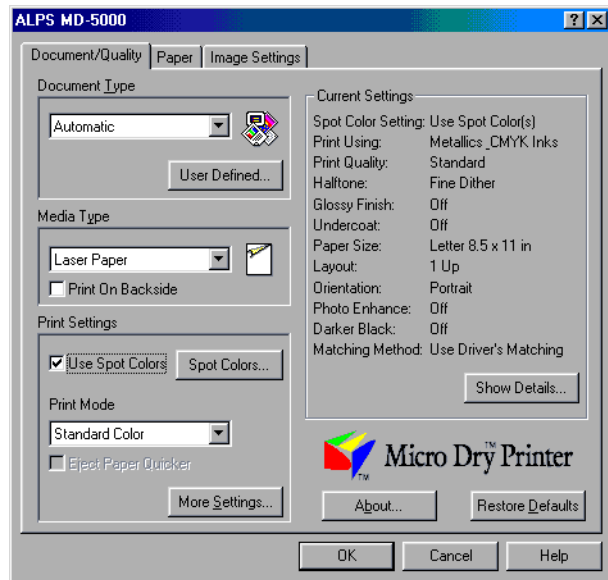

5. Check Use Spot Colors check box so that the Spot Colors dialog box is displayed.

6. Click the Use Spot Color(s) radio button.

7. Set Print Using to Multiple Inks.

8. Enabled ink cartridges among those installed in the printer are displayed in Select Ink Cartridge(s). Click the radio button(s) of the ink cartridge(s) to be used.

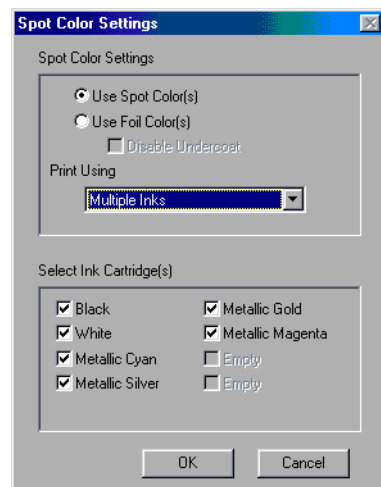

**Note**

- If bidirectional communication is not possible, all the usable cartridges are displayed.
- Even though you have set the color of an area to your desired color, the area will not be printed if the corresponding ink cartridge has not checked.

-
9. When you complete the setup, click OK to close the dialog box.

Step 5 ► Print

Click OK in the Print dialog box to start printing.

Simultaneous Metallics & CMYK Inks Printing

This section explains how to print Metallics & CMYK Inks simultaneously. This printing method differentiates between spot color and full color areas depending on their color composition. For this reason, it is necessary to assign the proper color to each area. This printing method is used with applications that allow the user to specify color compositions.

Requirements

For simultaneous Metallics & CMYK Inks printing you will need the following.

- **Ink cartridges**

The following ink cartridges can be used with Metallics & CMYK Inks printing.

- Metallic gold ink cartridge (Part No. 106030-00)
- Metallic silver ink cartridge (Part No. 106045-00)
- Metallic magenta ink cartridge (Part No. 106035-00)
- Metallic cyan ink cartridge (Part No. 106040-00)
- Cyan ink cartridge (Part No. 106020-00)
- Magenta ink cartridge (Part No. 106015-00)
- Yellow ink cartridge (Part No. 106010-00)
- Black ink cartridge (Part No. 106005-00)
- Finish II ink cartridge (Part No. 105144-00)
- VPhoto Primer ink cartridge (Part No. 105142-00)

- **Media**

Spot color printing does not require special paper. Plain paper, smooth paper, or greeting cards can be used just as with normal color printing.



Note

White ink cartridge cannot be used for simultaneous Metallics & CMYK Inks printing.

Step 1 ► Create the Full Color + Spot Color Print Image**1. Create the full color and spot color data to be printed.**

It is not necessary to prepare the spot color and full color images separately as with full color + spot color printing using Overlay mode. The data is prepared on the same page. Areas to be printed with spot ink and those to be printed in full color are indicated by their respective screen colors.

**Note**

There is a small range of color composition values that will be interpreted by the printer as indicating spot colors. Because of this, photographs and other data with large numbers of different colors may have areas that match the spot color designations and print partially in spot color. When printing images that contain data such as photos, it is best to print full color + spot color using Overlay mode.

2. Set the image areas to be printed in spot color to colors that correspond to the spot colors you want to use.

The colors (and color compositions) associated with spot colors are shown in the following tables.

■ Color composition for indicating spot colors

When printing full color and spot color simultaneously, the spot colors are designated by corresponding color compositions on the screen.

Spot color	Application color used to indicate the spot color
Metallic Gold	Yellow (or yellow-orange)
Metallic Silver	Gray
Metallic Magenta	Magenta, Red (a red close to magenta)
Metallic Cyan	Cyan, Blue (a blue close to cyan)

• Color compositions using RGB settings (n/255)

Spot color	R	G	B
Metallic Gold	225	160	0
Metallic Silver	189	193	197
Metallic Magenta	163	36	115
Metallic Cyan	0	176	201

• Color compositions using RGB settings (n/100%)

Spot color	R	G	B
Metallic Gold	88	63	0
Metallic Silver	74	76	77
Metallic Magenta	64	14	45
Metallic Cyan	0	69	79

• Color compositions using CMYK settings (n/100%)

Spot color	C	M	Y	K
Metallic Gold	12	37	100	0
Metallic Silver	26	24	23	0
Metallic Magenta	36	86	55	0
Metallic Cyan	100	31	21	0



Note

See your application's manual for instructions on setting up color components in your application. Using CMYK to specify color components may result in colors that do not match the desired spot colors.

Also, some applications make internal adjustments to produce the displayed color components. In such cases, the color components cannot be restricted and therefore spot colors cannot be used.

Color compositions different from those shown above will be interpreted and printed as normal full color.

Step 2 ► Install the Ink Cartridges

Install the ink cartridges that you are going to print. With the Metallics & CMYK Inks mode, you can print your document in full color plus up to three spot colors of your choice without having to change ink cartridges. You can also print your document up to four spot colors by changing the ink cartridges when the instructions message dialog appears.

Step 3 ► Load Paper in Your Printer

The method used for loading paper depends on the paper type. Use manual feed mode for thick paper and greeting cards. For plain paper, laser paper, and High Grade Paper, you may also use automatic feed mode to print a number of sheets at one time. For details, see the section entitled "Loading Paper" in Chapter 1.

1. For manual feed mode, set the paper feed switch to position "M"; for automatic feed mode, set it to "A".

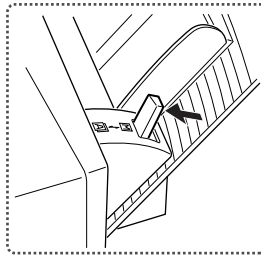

Paper feed switch 'A'

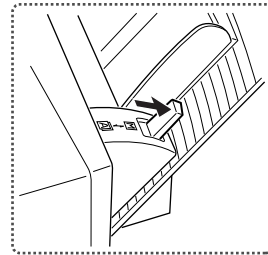

Paper feed switch 'M'

2. For Letter / A4 paper, fully extend the paper support.

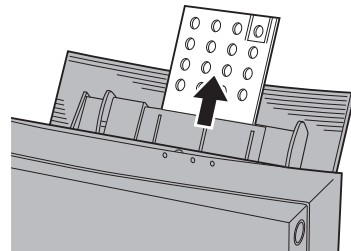

3. Adjust the paper feed guide to the width of the paper.

4. For manual feeding, load one sheet of paper into the sheet feeder and press the *ready / insert* button. For automatic feeding, load all of the sheets together.

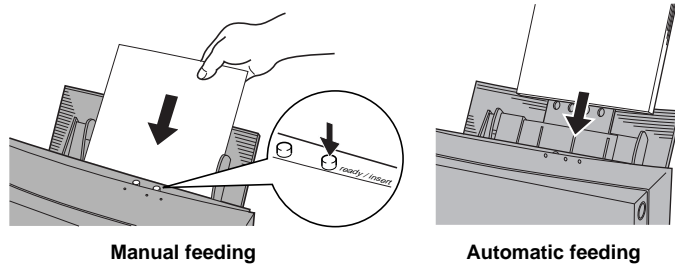

Step 4 ► Set Up the Printer Driver for Printing

1. Select Print from the File menu to open the Print dialog box, then click Properties.

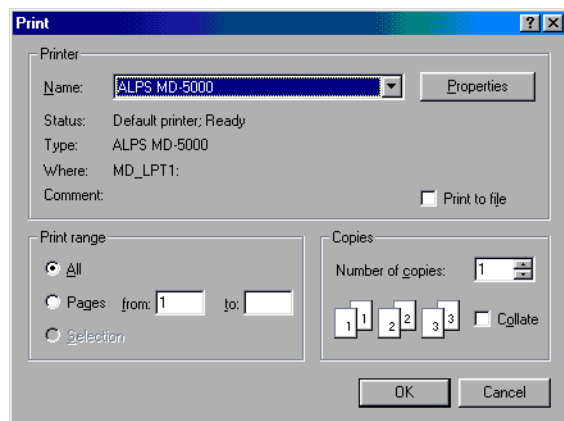

2. Click the Document/Quality tab to bring this portion to the front.
3. Select Automatic, Photographs, or Graphics/Text from the Document Type.

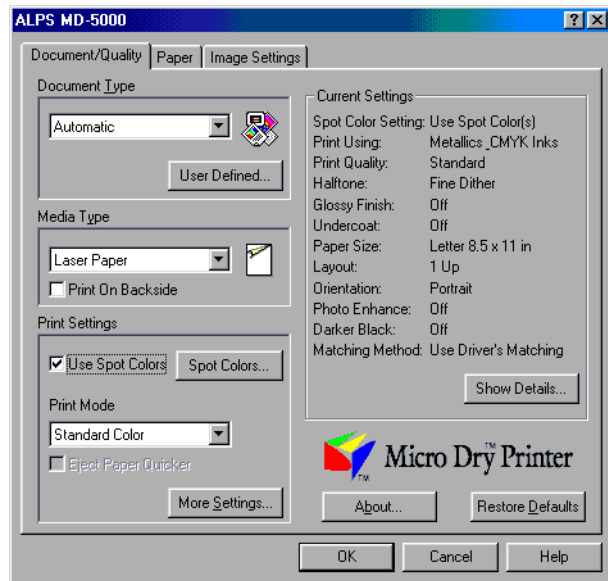
4. Set Media Type to the paper used.

5. Change the necessary settings.

6. Check Use Spot Colors check box so that the Spot Colors dialog box is displayed.

7. Click the Use Spot Color(s) radio button.

8. Set Print Using to Metallics & CMYK Inks.

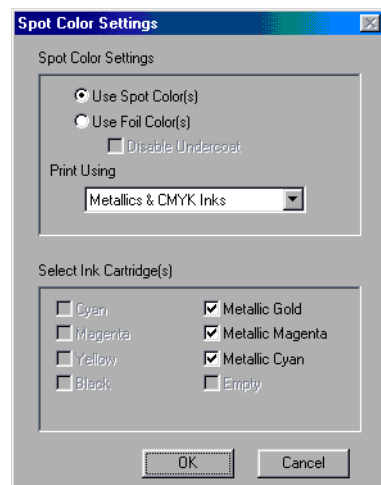
9. Enabled ink cartridges among those installed in the printer are displayed in Select Ink Cartridge(s). Click the radio button(s) of the ink cartridge(s) to be used.

**Caution**

- If bidirectional communication is not possible, all the usable ink cartridges are displayed.
- Even though you have set the color of an area to your desired color, the area will not be printed if the corresponding ink cartridge has not checked.

10. When you complete the setup, click OK to close the dialog box.

Step 5 ► Print

Click OK in the Print dialog box to start printing.

**Note**

If a required foil color ink cartridge is not installed, the warning message will be displayed. In this case, exchange ink cartridges as you indicated.

Printing in Foil Color

Foil color printing is one of the unique features of the ALPS MD-5500 printers. Although most applications are not designed to handle foil color printing, the MD-5500 printer driver allows you to select specific colors or color components that will be replaced by foil colors and black ink when printing. You can print with up to two foil colors (or two foil colors plus black) from most applications that allow color specification.

Moreover, because foil inks are opaque, foil color printing is unaffected by the color of the underlying paper. As a result, you can print on colored plain paper.



Caution

- **Special color ink is used for foil color printing. Therefore, undercoat must be provided with cyan, magenta, yellow, and black inks before printing Foil Color.**
- **Depending on the font type, size or paper type, Foil Color ink might not be applied well.**

Types of Foil Color Printing

The following types of foil color printing are possible depending on the number of ink cartridges used.

- **Single foil color printing (without halftone)**

Foil color printing uses a single color (gold or silver).

- **Multi foil color printing**

Foil color printing uses two colors (gold and silver).

- **Full color + foil color printing**

Full color printing and foil color printing is executed simultaneously.

Single Foil Color Printing

Single foil color printing uses just one color. Only the foil color to be used is installed in the printer. This method is used when an entire image or document is going to be printed in a single foil color. This method of printing can be used even when the application you are using does not allow designation of color components. Using this method, even grayscale images can be printed in foil color.

Requirements

For single foil color printing you will need the following.

- **Media**

Normal paper such as plain paper, Laser Paper, postcards, etc. can be used just as with normal color printing.

In case of Greeting Cards (Part No. 106090-00), single foil color printing can be executed only on the paper (not glossy) side.

- **Ink cartridges**

For single foil color printing, use either of the following ink cartridges.

Gold Foil ink cartridge (Part No. 105148-00)

Silver Foil ink cartridge (Part No. 105150-00)

The following ink cartridges are also necessary for undercoating.

Cyan ink cartridge (Part No. 106020-00)

Magenta ink cartridge (Part No. 106015-00)

Yellow ink cartridge (Part No. 106010-00)

Black ink cartridge (Part No. 106005-00)

Step 1 ► Prepare the Image to Be Printed

Use any application to create the image or document you want to print, and prepare it just as you would for normal printing.



Note

It is not necessary to select a color in the application that matches the color of the ink cartridge in the printer. Leaving the characters and images in black is fine.

Step 2 ► Install the Ink Cartridges

Install the desired foil color, cyan, magenta, yellow, and black ink cartridges into the ink cartridge holders. The ink cartridges may be installed in any order. For details, please refer to the section entitled "Installing Ink Cartridges" in Chapter 1.

Step 3 ► Load the Paper in Your Printer

The method used for loading paper depends on the paper type. Use manual feed mode for cardboard (thick paper) and greeting cards. For plain paper or Laser Paper, you may also use automatic feed mode to print a number of sheets at one time. For details, refer to the section entitled 'Loading Paper' in Chapter 1.

1. For manual feed mode, set the paper feed switch to position 'M'; for automatic feed mode, set it to 'A'. However, be sure to set the switch to "M" for postcards.
2. For Letter paper, fully extend the paper support.
3. Adjust the paper feed guide to the width of the paper.
4. For manual feeding load one sheet of paper into the sheet feeder and press the *ready/insert* button. For automatic feeding, load all of the sheets together.

Step 4 ► Set Up the Printer Driver for Printing

1. Select Print from the File menu to open the Print dialog box, then click Properties.

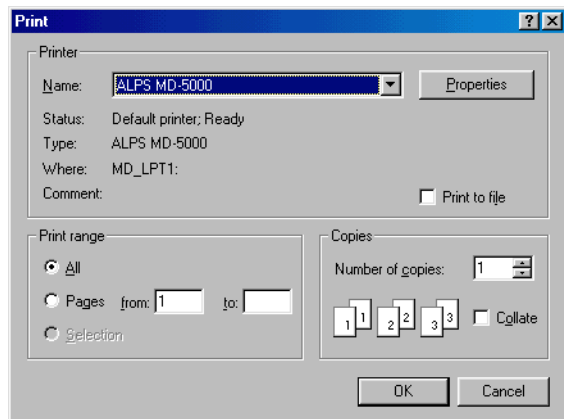

2. Click the Document/Quality tab to bring this portion to the front.
3. Set Document Type to an option appropriate to the document to be printed.

4. Set Media Type depending on the paper used.

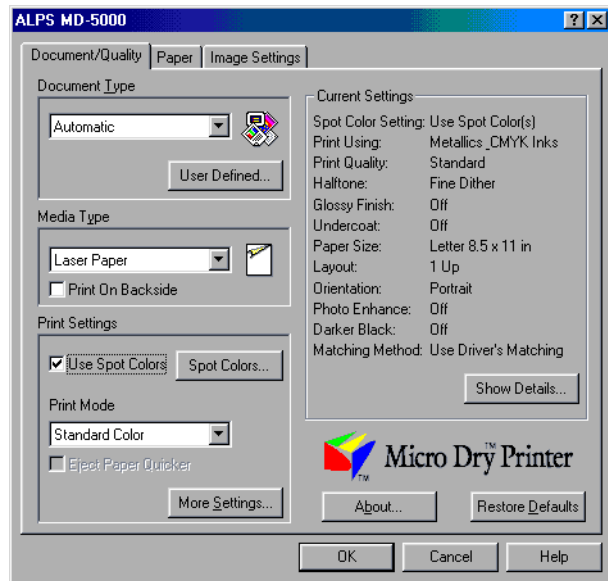

5. Check Use Spot Colors check box so that the Spot Colors dialog box is displayed.

6. Click the Use Foil Color(s) radio button.

7. Set Print Using to Single Ink.

8. Enabled ink cartridges among those installed in the printer are displayed in Select Ink Cartridge(s). Click the radio button(s) of the ink cartridge(s) to be used.

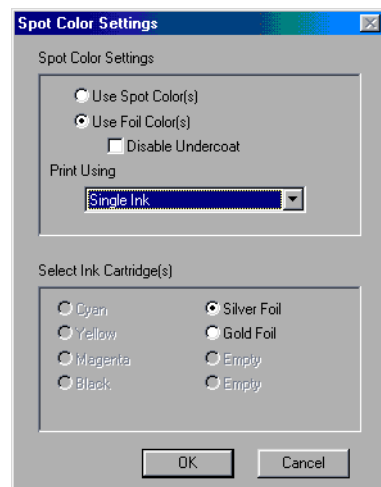



Caution

If bidirectional communication is not possible, all the usable ink cartridges are displayed.

9. When you complete the setup, click OK to close the dialog box.

Step 5 ► **Print**

Click OK in the Print dialog box to start printing.

Multi Foil Color Printing

Use the steps outlined here for foil color printing using two foil color ink cartridges. By associating each foil color with a color (or color component) in your application, you can print with two foil colors or two foil colors plus black. You can use this method with most applications that support color.

Requirements

For multi foil color printing you will need the following.

- **Media**

Normal paper such as plain paper, Laser Paper, postcards, etc. can be used just as with normal color printing.

In case of Greeting Cards (Part No. 106090-00), multi foil color printing can be executed only on the paper (not glossy) side.

- **Ink cartridges**

When printing with multiple foil color inks, as many as two of the following ink cartridges can be used.

Gold Foil ink cartridge (Part No. 105148-00)

Silver Foil ink cartridge (Part No. 105150-00)

The following ink cartridges are also necessary for undercoating.

Cyan ink cartridge (Part No. 106020-00)

Magenta ink cartridge (Part No. 106015-00)

Yellow ink cartridge (Part No. 106010-00)

Black ink cartridge (Part No. 106005-00)

Step 1 ► Prepare the Image to Be Printed

Use any application to create the image or document you want to print. Usually create text and graphic object data. Then set the colors corresponding to each foil color you want to use. For example, set the parts of the image that you want to print in gold foil to yellow and those of the image that you want to print in silver foil to white. When you want to print foil colors and black simultaneously, set the area you want to print in black, too.

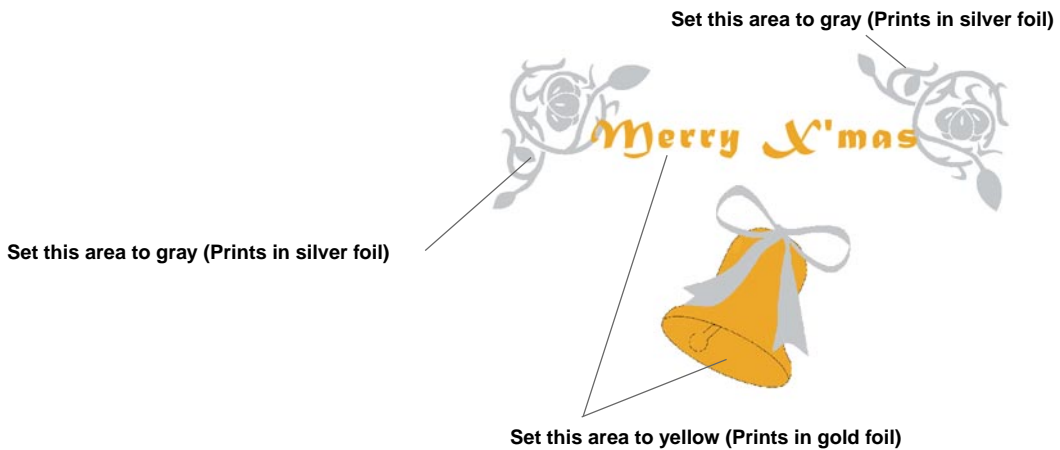
**Caution**

Since all of the color and grayscale data is binarized in multi color printing, gradation cannot be represented.

**Note**

White portions of data (R=G=B=100%) are not printed.

For the colors (and color components) associated with foil colors, see the following table.

■ Colors (and color components) used to indicate foil colors

In multi foil color printing, indicate foil colors by selecting colors in the application that resemble the foil colors. As much as possible, try to select colors that resemble the colors listed in the table below. In applications that do not have many color choices, such as word processors, closely related colors can be used.

Foil color	Application color used to indicate the foil color
Gold foil	Yellow (or yellow-orange)
Silver foil	Gray
(Normal) Black	Normal black (R=G=B=0 or C=M=Y=0, K=100)

• Color compositions using RGB settings (n/255)

Foil color	R	G	B
Gold foil	225	160	0
Silver foil	189	193	197

• Color compositions using RGB settings (n/100%)

Foil color	R	G	B
Gold foil	88	63	0
Silver foil	74	76	77

• Color compositions using CMYK settings (n/100%)

Foil color	C	M	Y	K
Gold foil	12	37	100	0
Silver foil	26	24	23	0



Note

For instructions on changing color component settings in an application, refer to the manual that came with your application. Depending on the application, a foil color may not print correctly even though the color settings were properly set in the application. Check the Preview window before printing, and try increasing or decreasing the setting to get the correct foil color to print.

Step 2 ► Install the Ink Cartridges

Install all the foil color ink cartridges you want to use. The ink cartridges may be installed in any order.

Step 3 ► Load the Paper in Your Printer

The method used for loading paper depends on the paper type. Use manual feed mode for cardboard (thick paper) and greeting cards. For plain paper or Laser Paper, you may also use automatic feed mode to print a number of sheets at one time. For details, see the section entitled 'Loading Paper' in Chapter 1.

1. **For manual feed mode, set the paper feed switch to position 'M'; for automatic feed mode, set it to 'A'.**
2. **For Letter paper, fully extend the paper support.**
3. **Adjust the paper feed guide to the width of the paper.**
4. **For manual feeding load one sheet of paper into the sheet feeder and press the ready/insert button. For automatic feeding, load all of the sheets together.**

Step 4 ► Set Up the Printer Driver for Printing

1. **Select Print from the File menu to open the Print dialog box, then click Properties.**

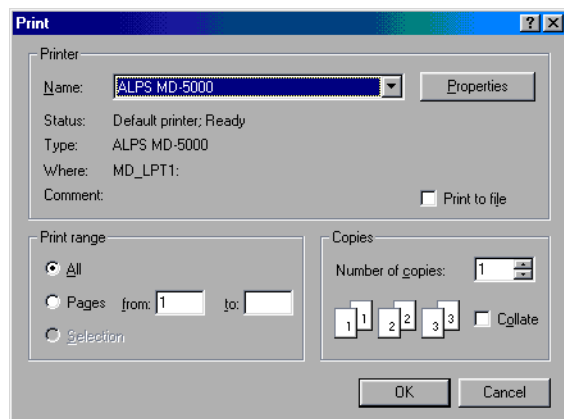

2. **Click the Document/Quality tab to bring this portion to the front.**

3. Set Document Type to an option appropriate to the document to be printed.
4. Set Media Type depending on the paper used.

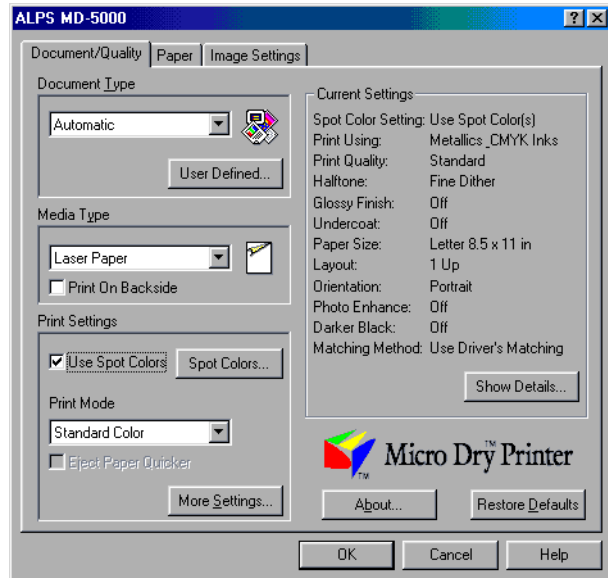

5. Check Use Spot Colors check box so that the Spot Colors dialog box is displayed.
6. Click the Use Foil Color(s) radio button.
7. Set Print Using to Multiple Inks.
8. Enabled ink cartridges among those installed in the printer are displayed in Select Ink Cartridge(s). Click the radio button(s) of the ink cartridge(s) to be used.

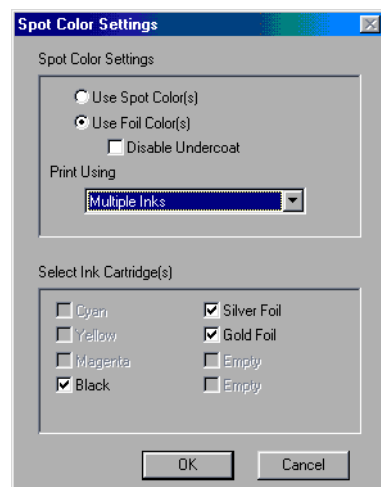

**Note**

- If bidirectional communication is not possible, all the usable cartridges are displayed.
- Even though you have set the color of an area to your desired color, the area will not be printed if the corresponding ink cartridge has not checked.

-
9. When you complete the setup, click OK to close the dialog box.

Step 5 ► Print

Click OK in the Print dialog box to start printing.

Simultaneous Full Color + Foil Color Printing

This section describes how to print full color + foil color simultaneously. This printing method differentiates between foil color and full color areas depending on their color component. For this reason, it is necessary to assign the proper color to each area. This printing method is used with applications that allow the user to specify color components.

Requirements

For simultaneous full color + foil color printing you will need the following.

- **Media**

Normal paper such as plain paper, Laser Paper, postcards, etc. can be used just as with normal color printing.

- **Ink cartridges**

The following ink cartridges can be used for simultaneous full color + foil color printing.

Gold Foil ink cartridge (Part No. 105148-00)

Silver Foil ink cartridge (Part No. 105150-00)

Cyan ink cartridge (Part No. 106020-00)

Magenta ink cartridge (Part No. 106015-00)

Yellow ink cartridge (Part No. 106010-00)

Black ink cartridge (Part No. 106005-00)

Finish II ink cartridge (Part No. 105144-00)

VPhoto Primer ink cartridge (Part No. 105142-00)



Caution

Special color ink is used for foil color printing. Therefore, undercoat must be provided with cyan, magenta, yellow, and black inks before printing Foil Color.

Step 1 ► Prepare the Image to Be Printed

Create the data you want to print, then set the image areas to be printed in foil colors to colors that correspond to the foil colors you want to use.

For the colors (and color components) that correspond to each foil color, please refer to the tables below.

**Note**

There are a small range of color component values that will be interpreted by the printer as indicating foil colors. Because of this, photographs and other data with large numbers of different colors may have areas that match the foil color designations and print partially in foil color. When printing images that contain data such as photos, it is best to print full color + foil color using Overlay mode.

■ Colors (and color components) used to indicate foil colors

In simultaneous full color + foil color printing, indicate foil colors by selecting the corresponding color component for each foil color. For characters of which number of points is 32 or more, select the following approximate colors.

Foil color	Application color used to indicate the foil color
Gold foil	Yellow (or yellow-orange)
Silver foil	Gray

• Color compositions using RGB settings (n/255)

Foil color	R	G	B
Gold foil	225	160	0
Silver foil	189	193	197

• Color compositions using RGB settings (n/100%)

Foil color	R	G	B
Gold foil	88	63	0
Silver foil	74	76	77

• Color compositions using CMYK settings (n/100%)

Foil color	C	M	Y	K
Gold foil	12	37	100	0
Silver foil	26	24	23	0

**Note**

- See your application's manual for instructions on setting up color components in your application. Using CMYK to specify color components may result in colors that do not match the desired foil colors.
- Also, some applications make internal adjustment to produce the displayed color components. In such cases, the color components cannot be restricted and therefore foil colors cannot be used. When using such an application, use the Overlay mode.
- There are a small range of color component values that will be interpreted by the printer as indicating foil colors. Because of this, areas of which color component values are close to a foil color are also printed in the foil color.

Step 2 ► Install the Ink Cartridges

Install the necessary ink cartridges into the ink cartridge holders. In simultaneous full color + foil color printing, up to two foil colors can be used provided that full color printing is executed with cyan, magenta, yellow, black, and Finish inks. Even when undercoating using VPhoto Primer ink, simultaneous full color + foil color printing is possible by exchanging ink cartridges when the corresponding message is displayed.

Step 3 ► Load the Paper in Your Printer

The method used for loading paper depends on the paper type. Use manual feed mode for cardborad (thick paper) and greeting cards. For plain paper or Laser Paper, you may also use automatic feed mode to print a number of sheets at one time. For details, see the section entitled 'Loading Paper' in Chapter 1.

1. For manual feed mode, set the paper feed switch to position 'M'; for automatic feed mode, set it to 'A'.
2. For Letter paper, fully extend the paper support.
3. Adjust the paper feed guide to the width of the paper.
4. For manual feeding load one sheet of paper into the sheet feeder and press the *ready/insert* button. For automatic feeding, load all of the sheets together.

Step 4 ► Set Up the Printer Driver for Printing

1. Select Print from the File menu to open the Print dialog box, then click Properties.

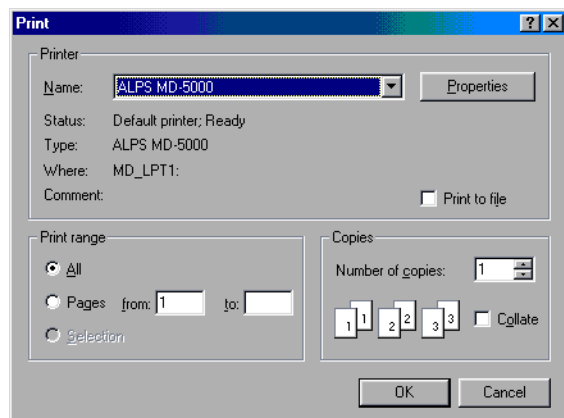

2. Click the Document/Quality tab to bring this portion to the front.
3. Select Automatic, Photographs, or Graphics/Text from the Document Type.
4. Set Media Type to the paper used.

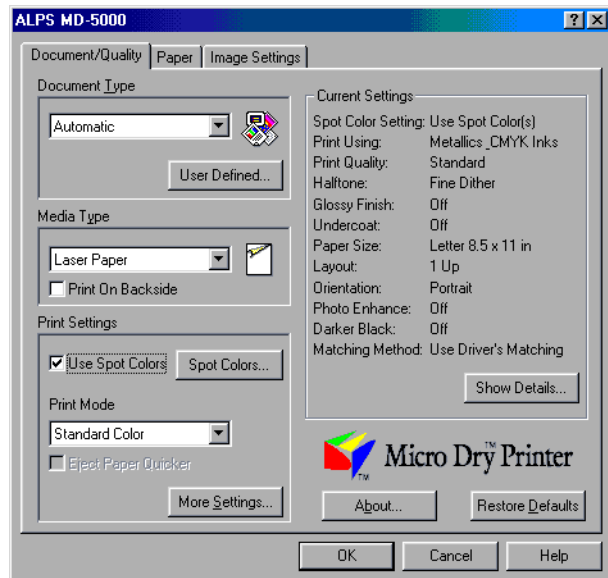

5. Change the necessary settings.
6. Check Use Spot Colors check box so that the Spot Colors dialog box is displayed.
7. Click the Use Foil Color(s) radio button.
8. Set Print Using to Metallics & CMYK Inks.
9. Enabled ink cartridges among those installed in the printer are displayed in Select Ink Cartridge(s). Click the radio button(s) of the ink cartridge(s) to be used.

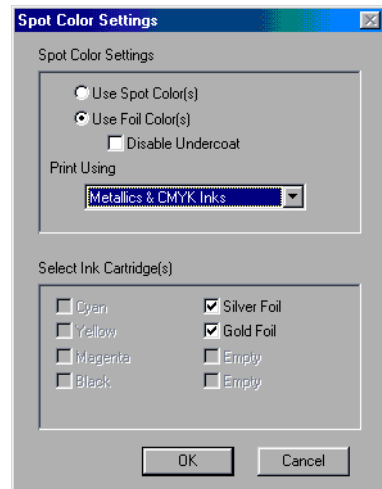

Caution

- If bidirectional communication is not possible, all the usable ink cartridges are displayed.
- Even though you have set the color of an area to your desired color, the area will not be printed if the corresponding ink cartridge has not checked.

10. When you complete the setup, click OK to close the dialog box.

Step 5 ► Print

Click OK in the Print dialog box to start printing.



Note

If a required foil color ink cartridge is not installed, the warning message will be displayed. In this case, exchange ink cartridges as you indicated.

Printing Greeting Cards

This section describes step by step operation for printing on greeting cards. By combining full color and metallic color printing, you can create many different looks for your greeting cards.

Requirements

For printing on greeting cards, you will need the following.

- **Ink cartridges**

The following ink cartridges can be used.

- Cyan ink cartridge (Part No. 106020-00)
- Magenta ink cartridge (Part No. 106015-00)
- Yellow ink cartridge (Part No. 106010-00)
- Black ink cartridge (Part No. 106005-00)
- Gold Foil ink cartridge (Part No. 105148-00)
- Silver Foil ink cartridge (Part No. 105150-00)
- Metallic gold ink cartridge (Part No. 106030-00)
- Metallic silver ink cartridge (Part No. 106045-00)
- Metallic magenta ink cartridge (Part No. 106035-00)
- Metallic cyan ink cartridge (Part No. 106040-00)
- White ink cartridge (Part No. 106050-00)
- Finish II ink cartridge (Part No. 105144-00)
- VPhoto Primer ink cartridge (Part No. 105142-00)



Caution

On the glossy side of greeting cards, **ALWAYS** use metallic color ink cartridges.

- **Media**

Use the greeting cards specifically designed for your printer.

- Greeting Card set (Part No. 106090-00)



Caution

- Always use the above listed greeting cards. Using some other type of cards can cause the printer to malfunction.
- Do not bend the greeting cards before loading them on the printer. Once you have bent a card, you may not be able to obtain satisfactory printing results around the crease.

Step 1 ► Prepare the Image to Be Printed

Create the text and graphic objects with an application, and lay them out within the printing area of a greeting card.

Step 2 ► Install the Ink Cartridges.

1. Install the ink cartridges into the ink cartridge holders.

Step 3 ► Load the Greeting Card into the Printer

Manual feed mode is used for this printing.

1. Set the paper feed switch to position "M".
2. Adjust the paper feed guide to the width of the paper plus several millimeters.
3. Face the printing surface upward, load the card into the sheet feeder, and press the *ready / insert* button.

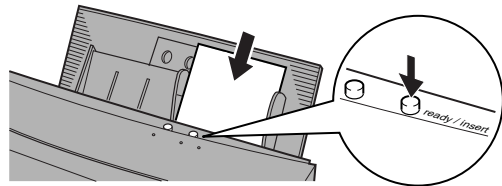
**Note**

Provide a gap of several millimeters between the paper feed guide and the greeting card. Otherwise, the card may not feed in correctly.

Step 4 ► Set Up the Printer Driver for Printing

1. Select **Print** from the **File** menu of your application. Click the **Properties** button in the **Print** window.

The printer driver settings window appears.

**Note**

Please note that the procedure for opening the dialog box to set up the printer driver may slightly differ from one application to another.

2. Select the appropriate document type in the **Document Type** setting.

3. Set the Media Type to Cardboard (Thick paper).

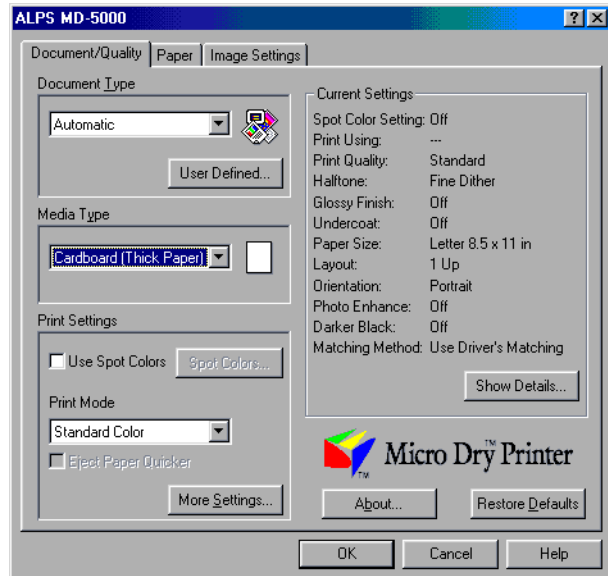

4. Set the Paper Size to User Defined to open the paper size specification dialog box. Set the Paper Width to 5.83 inches, and the Paper Length to 7.87 inches, and click OK.

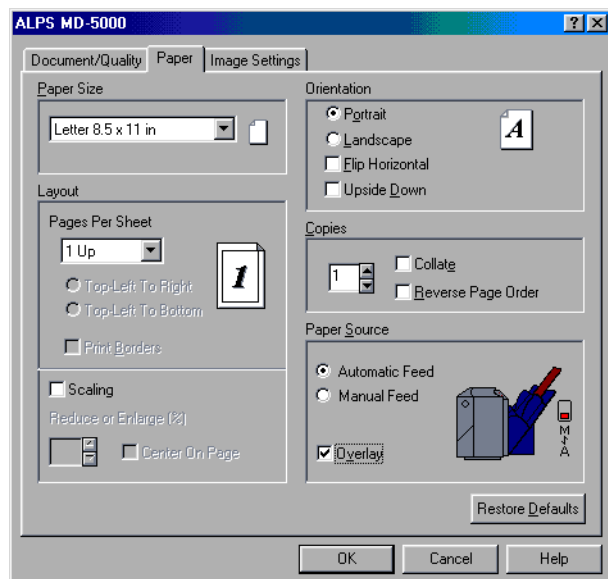

5. When you complete all the setup, click OK to close the dialog box.

Step 5 ► Print

1. Click OK in the Print dialog box. Printing will begin.

Printing on Back Print Film

This section explains the steps for printing illustrations and photographs on back print film. Attaching printed back print film to paper with an iron gives the final image a glossy finish like a photograph. Also, a finishing sheet that can be used to create a matte (non-glossy) finish is included.



Note

- Back print film printing is basically the same as normal color printing. However, special sheets are used in place of paper. Hold the sheets by the edge when inserting them into the printer to avoid touching the printing side.
- Images printed on back print film should only be transferred to white paper. Colored paper may affect the colors of the printed image.

Requirements

For back print film printing you will need the following.

- **Back Print Film**
- **Finishing Sheet**
- **Matte Finishing Sheet**

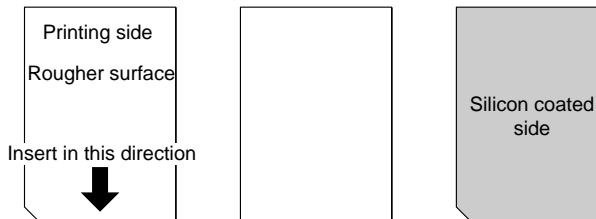

The back print film sheets, the finishing sheets, and the matte finishing sheet come together in a single package of Back Print Film (Part No. 106080-00).

- **Paper to transfer the image to :**

We recommend High Grade Paper (Letter) (Part No. 106085-00).

Plain paper may be used but, depending on the pattern of the image, the image may pick up the unevenness in the paper and appear rough. Also, glossy paper traps pockets of air and does not work well.

- **Ink cartridges**

The following ink cartridges may be used.

- Cyan ink cartridge (Part No. 106020-00)
- Magenta ink cartridge (Part No. 106015-00)
- Yellow ink cartridge (Part No. 106010-00)
- Black ink cartridge (Part No. 106005-00)
- White ink cartridge (Part No. 106050-00)

- **Iron**

Use an ordinary household iron. Do not use steam. Set the iron to Dry.

Step 1 ► Prepare the Image to Be Printed

Use an application and create the image to be printed.

There are no special considerations in creating the image. Prepare the image just as you would for normal color printing.

**Step 2 ► Install the Ink Cartridges and Load the Back Print Film into the Printer**

1. Install the ink cartridges into the ink cartridge holders.

**Note**

When printing on back print film, use only standard color cyan, magenta, yellow, or black ink cartridges. Do not use metallic ink cartridges.

2. Set the paper feed switch to position "M".

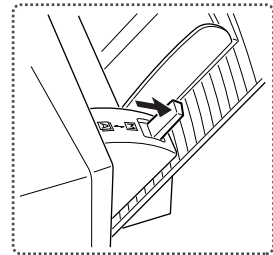

3. Insert the back print film into the printer.

Insert the back print film into the printer with the printing side up (so that the cut corner is in the lower left corner).

Back Print Film

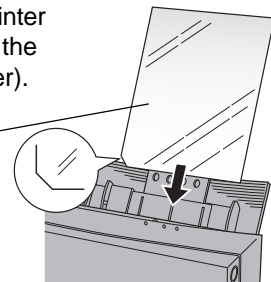

4. Adjust the paper feed guide to the paper side.
5. Press the *ready/insert* button, while holding the paper so that it will not fall.

Step 3 ► Set Up the Printer Driver for Printing

1. Select Print from the File menu of your application. Click the Properties button in the Print window.

The printer driver settings window appears.



Note

Please note that the procedure for opening the dialog box to set up the printer driver may slightly differ from one application to another.

2. Select the appropriate document type in the Document Type setting.

Normally, use Photographs.

3. Set the Media Type to Back Print Film.

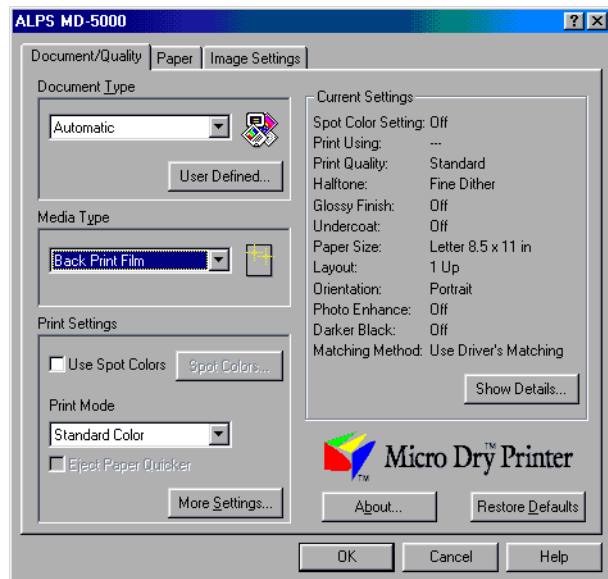

4. Set the Paper Size to A4 210 x 297mm, and change any other necessary settings such as orientation.

When Back Print Film is selected under the Media Type setting, the paper feed setting in the Document/Quality Tab is automatically changed to Manual Feed and the Flip Horizontal check box is checked.

- When you complete the setup, click OK to close the dialog box.

Step 4 ► Print

- Click OK in the Print dialog box.
Printing will begin.

Step 5 ► Transfer the Image to Paper using an Iron

Transfer the image to paper (using an iron) after printing on the back print film is completed.

- Cut around the printed image as close to the edges of the image as possible.

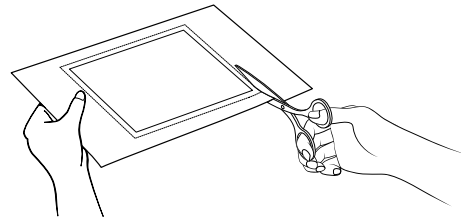

- Place the film on paper with the image in contact with the paper. Place the finishing sheet on top and apply even pressure with an iron.

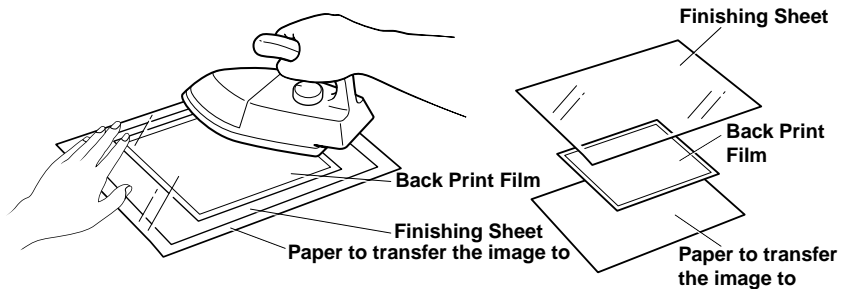

Note

- Use paper larger than the size of the image.
- Taking care not to let the film slip, firmly apply pressure with the iron until the image is completely attached to the paper.

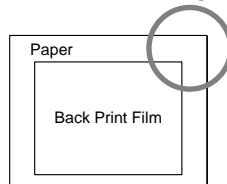

Back Print Film fits on the paper

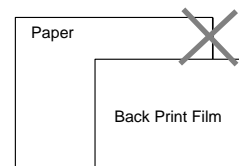

Back Print Film extends beyond the edge of the paper

- If insufficient pressure is applied to the image, bubbles can form when the film is lifted off. Make sure to apply enough pressure, particularly around the edges and corners.
- Set the iron for 160°C/320°F (cotton). If the iron has outlet holes for steam, set the iron to Dry and avoid the holes, using a flat part of the iron.

3. Lift off the finishing sheet after the paper and the film have cooled completely.



Note

If the paper and film have not cooled completely, the film will not come off smoothly.

4. Starting with the corners, peel off the film, making sure that the film comes off smoothly.

Step 6 ► Curl Correction

When you transfer an image on a thin sheet of paper, the sheet may still be curled up after peeling off the back print film. In this case, correct the curl with the following procedure.

1. Place a sheet of plain paper (paper for copiers) on top of the transferred image on the curled sheet.

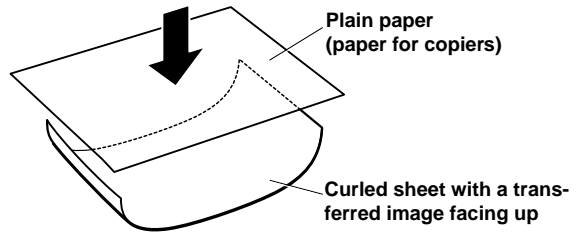

2. Roll up both sheets together with an approximate diameter of 1 inch to resist the curl.

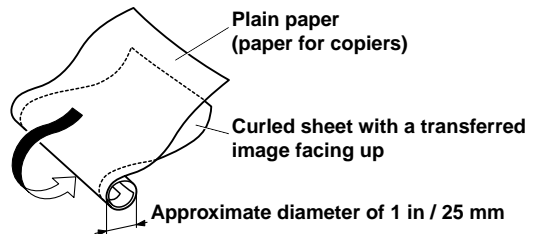

3. Leave them rolled up for five minutes.

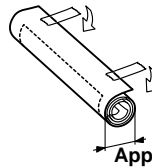

Approximate diameter of 1 in / 25 mm

4. Unroll them, and the curl should be corrected.



Note

Do not leave the back print film attached to the transfer sheet too long after the transfer. Doing so will make the sheet get curled up more tightly.

Now you have an image with glossy finish.

Step 7 ► Obtain a Matte Finish

If you want to create a matte finish, perform the following steps after completing the steps for making a glossy finish.

1. Place the matte finishing sheet on the image side of the paper with the silicon coated side face down (so that the cut corner is in the lower left corner).

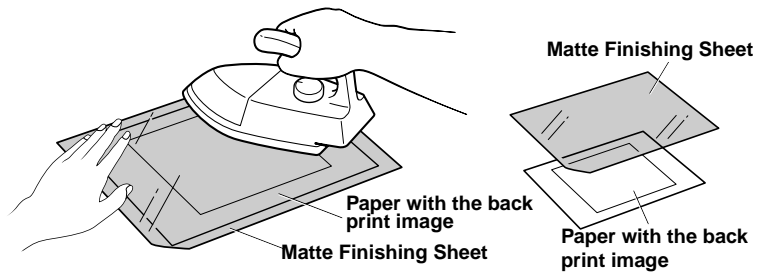

2. Apply the iron.

Carefully use the iron to apply heat and pressure evenly.

3. After the paper has cooled completely, lift off the matte finishing sheet.



Note

What to do when the image does not print well
When printing on back print film in one or more colors, the print results may appear rough if printed in high resolution mode (600 dpi). In such cases, click on Quality tab and select, Standard Dither or Coarse Dither under Halftone before printing. This will make the image appear rougher on the screen but should produce better print results.

Examples

You can use back print film for many different purposes, including posters, book covers, greeting cards, and more.

Making Iron-on Transfers

The special features of the MD-Series printers enable you to create iron-on transfers, which allow you to print illustrations and photos and then transfer them to cloth using an iron. With the iron-on transfer sheets, you can create one-of-a-kind T-shirts, handkerchiefs, and other items using family pictures, names, and so forth.



Note

Printing on Iron-on Transfer Sheets is identical to normal color printing except special sheets are used. When placing the sheets in the printer, care should be taken to avoid getting fingerprints, etc., on the printing surface of the sheets. Also, when preparing images, keep in mind that since the final image will be transferred to cloth, extremely fine print data or very small illustrations details may not show up well.

Requirements

The iron-on transfer sheets and the finishing sheet come together in a package of Iron-on Transfer Sheets (Part No. 106075-00). (Use only the sheets specified.)

• Ink cartridges

The following ink cartridges can be used.

Cyan ink cartridge (Part No. 106020-00)

Magenta ink cartridge (Part No. 106015-00)

Yellow ink cartridge (Part No. 106010-00)

Black ink cartridge (Part No. 106005-00)

White ink cartridge (Part No. 106050-00)



Note

Because the back side of the printed image is face up after it is transferred to cloth, opaque inks such as metallic color cannot be used for iron-ons.

• Iron

Use a regular household iron. Do not use steam. Set the iron to Dry.

• Cloth to transfer the image to (T-shirt, handkerchief, etc.)

Most cloth that is fairly smooth will work fine. The transferred image may peel off in the laundry if the cloth stretches or shrinks a lot, does not withstand heat well, or has a nap. These kinds of cloth should be avoided.



Note

Use iron-ons only on white cloth. Black or other colors will affect the printed color of the image.

Step 1 ► Prepare the Image to Be Printed

Use an application and create the data to be printed.

There are no special considerations for creating the data. Create the data just as you would for black or full color printing.

**Note**

- Because each iron-on transfer sheet can only be printed on once, try to use as much of the sheet as possible. If a 1/2 inch gap is left between images, several images can be printed on a single sheet. (Use a single sheet to create an image for several different pieces of cloth.)
- Large images that require more than one sheet can also be created.

Step 2 ► Install the Ink Cartridges and Load the Iron-On Transfer Sheet into the Printer

1. Install the ink cartridges into the ink cartridge holders.

**Note**

When printing on iron-on transfer sheets, use only standard color cyan, magenta, yellow, or black ink cartridges. Do not use metallic ink cartridges.

2. Set the paper feed switch to position "M".

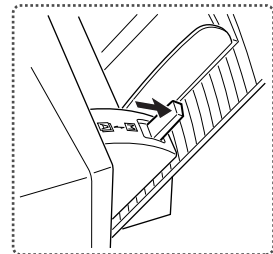

3. Insert the iron-on transfer sheet into the printer.

Insert the iron-on transfer sheet into the printer with the printing side up.

4. Adjust the paper feed guide to the paper size.

5. Press the *ready/insert* button, while holding the paper so that it will not fall.

Step 3 ► Set Up the Printer Driver for Printing

1. **Select Print from the File menu of your application. Click the Properties button in the Printer Setup window.**

The printer driver settings window appears.



Note

Please note that the procedure for opening the dialog box to set up the printer driver may slightly differ from one application to another.

2. **Select the appropriate document type under the Document Type setting.**

Normally, use Photographs.

3. **Set the Media Type to Iron-on Transfer Sheet.**

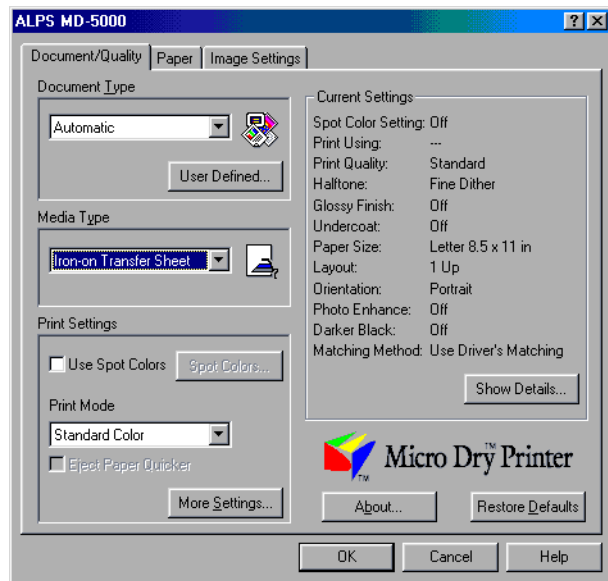

When Iron-on Sheet is selected under the Media Type setting, the paper feed setting in the Paper Tab is automatically changed to Manual Feed and the Flip Horizontal check box is checked.

4. **Set the Paper Size to A4 210 x 297 mm, and change any other necessary settings such as orientation.**
5. **When you complete the setup, click on OK to close the dialog box.**

Step 4 ► Print

1. **Click OK in the Print dialog box.**

Printing will begin.

Step 5 ► Transfer the Iron-On to Cloth

Use an iron to transfer the image to cloth after the printing on the iron-on transfer sheet is completed.

1. **Cut around the printed image as close to the edges of the image as possible.**

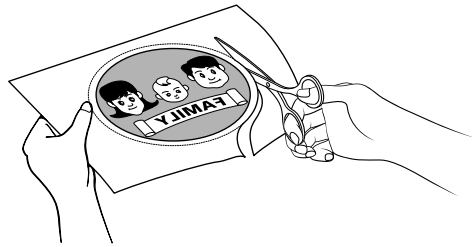

2. **Place the printed side on the cloth and press down evenly with an iron (set to dry).**

Using care not to let the iron-on transfer sheet shift, firmly apply pressure until the iron-on transfer is completely attached to the cloth.

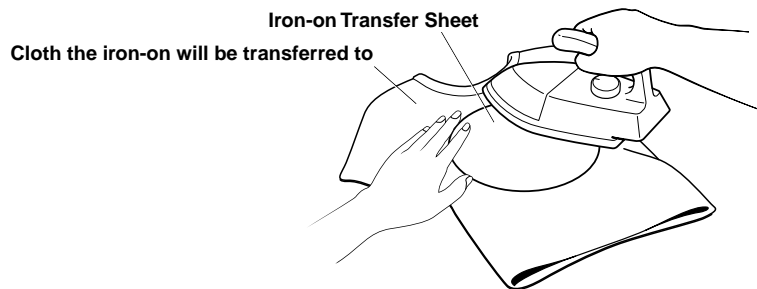
**Note**

- Use the iron to remove wrinkles in the cloth before affixing the iron-on.
- Set the iron heat to 160°C/320°F (cotton). If the iron has outlet holes for steam, set the iron to Dry and avoid the holes, using a flat part of the iron.

3. Remove the iron-on transfer sheet after the cloth has cooled completely.

Starting at the corners, make sure the iron-on is firmly attached to the cloth, and then carefully peel off the rest of the sheet. If the sheet does not come off cleanly, replace it, and then iron it again.

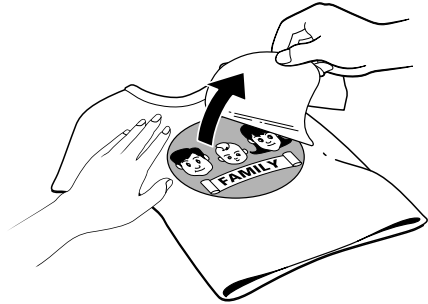

4. Place the finishing sheet on the cloth with the silicon coated side face down. Apply the iron again to completely affix the iron-on to the cloth.

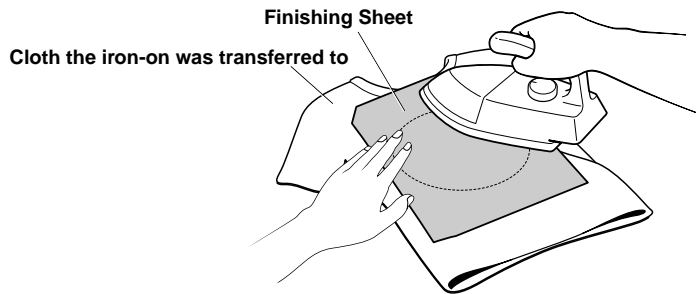

Note

The finishing sheet can be used many times. Do not discard it after using it.

5. Remove the finishing sheet after the cloth has cooled completely.



Caution

- The iron-on should withstand many washings but if it should begin to peel away again for some reason simply use the finishing sheet again to reattach it.
- Do not use dry cleaning. Also, the transferred image may peel off in the laundry if the cloth stretches or shrinks a lot, does not withstand heat well, or if the cloth has a nap. These kinds of cloth should be avoided.
- Note that once an iron-on has been applied it cannot be removed.
- Do not use bleach. Bleach may cause the colors in the printed image to run.
- Do not use the iron directly on the iron-on.
- Do not dry in a dryer.

**Note**

What to do when the image does not print well
When printing iron-on transfer sheets in one or more colors, the print results may appear rough if printed at higher print quality. In such cases, use Standard Dither from Halftone option in the Image Setting dialog box. This will make the image appear rougher on the screen but should produce better print results.

Examples

Here are some examples of places and ways to use iron-on transfers. Iron-on transfers can be used almost any way you can think of.

T-shirts, sweatshirts, uniforms, undergarments, handkerchiefs, napkins, name tags, children's accessories (school bag, gym bag, lunch bag), pillow case, sheets, slippers, computer covers, embroidery patterns, etc.

Iron-on transfers can be used not only onto fabric items:

You can obtain a variety of effects using the iron-on transfers. You can transfer an image not only onto fabric items, such as a T-shirt or a handkerchief, but also onto other materials including cork and wood. Here are some tips for transferring an image onto hard materials such as cork and wood.

■ **Material Selection**

- 1) Choose an object with a smooth surface. The plates with a processed surface available at do-it-yourself stores are most appropriate.
- 2) If the surface is rough, sand it smooth with sandpaper before transferring an image.

■ **Transfer Procedure**

Transferring an image onto wood is basically the same as for fabric. Please note the following points.

- 1) Place a thin piece of cloth between the iron-on transfer sheet and the iron for easier ironing. While ironing, press harder than you would for transferring an image onto fabric.
- 2) Wait until the iron-on transfer sheet cools down completely before peeling it off. Peel it off slowly, starting with one of the corners.
- 3) When ironing the finishing sheet, insert a thin piece of cloth between the finishing sheet and the iron for a more uniform result.
- 4) Wait until the finishing sheet cools down completely before peeling it off.

Printing on Overhead Transparencies

This section describes how to print graphics and text on overhead transparencies. This function allows you to print full color images on the overhead transparencies to quickly produce materials for presentations and numerous other occasions.

Requirements

For printing on overhead transparencies, you will need the following.

- **Ink cartridges**

The following ink cartridges can be used.

Cyan ink cartridge (Part No. 106020-00)

Magenta ink cartridge (Part No. 106015-00)

Yellow ink cartridge (Part No. 106010-00)

Black ink cartridge (Part No. 106005-00)

White ink cartridge (Part No. 106050-00)

- **Media**

Use only the sheets shown below.

Overhead Projector Transparency Film (Letter size) (Part No. 106065-00)



Caution

When printing on overhead transparencies, use only the above listed ALPS transparency films. Using other films may cause damage to the printer.

Step 1 ► Prepare the Image to Be Printed

Create the text and graphics with an application, and lay them out within the printing area of an overhead transparency film.

Step 2 ► Set up the Transparency Separators.

Under certain conditions, electrostatic build-up may cause a printing transparency to “pick up” an already completed page. This could lead to paper jams. To prevent this, please set up the transparency separators as described below.

- 1) With a pair of scissors, cut apart the separators by following the dotted lines, as shown here. Then discard the middle portion, keeping the two outer sections with folding lines.
- 2) Now fold the two separators along the fold lines as shown in the illustration. The folded angle on the separators should be less than 90 degrees.
- 3) Take the inner box of the overhead projector transparency film and insert it into the cover of the box, as shown in the illustration.
- 4) Insert the separators into each side of the box, between the outer cover and inner box as shown.



Note

WHEN THE SEPARATORS ARE IN PLACE, MAKE SURE THE FOLDED ANGLE IS LESS THAN 90 DEGREES SO THE TRANSPARENCIES WILL FALL DOWN INTO THE OPEN BOX.

- 5) Place the box with installed separators in front of the printer, and align the right edge of the box with the right edge of the paper output slot on the printer.

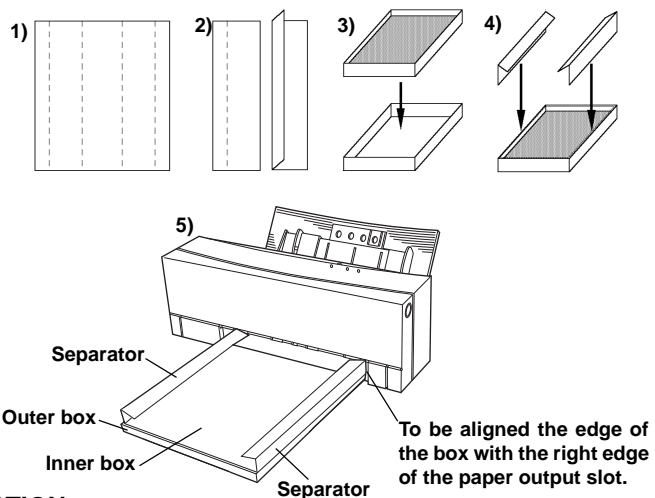

OPERATION

When transparencies are printing, they will ride on top of the separators, preventing them from “picking up” any completed transparencies lying below. When a transparency is completed, it will drop through the separators by the time the next sheet begins printing.

Step 3 ► Install the Ink Cartridges and Overhead Transparencies.

1. Install the ink cartridges in the ink cartridge holders.
2. Set the paper feed switch to position "A".

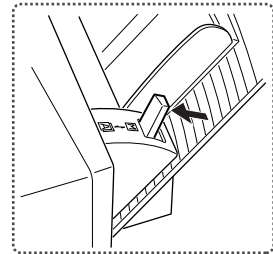

3. Place the overhead transparencies into the sheet feeder. Fan the transparencies to make sure they are separated.

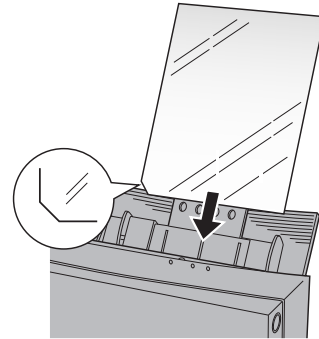

4. Adjust the paper feed guide to the paper size.

**Note**

- Place the transparencies with the printing side up so that the cut corner is on the lower left-hand corner.
- No more than 30 sheets can be loaded into the sheet feeder at any one time.

Step 4 ► Set Up the Printer Driver for Printing

1. **Select Print from the File menu of your application. When the dialog box appears, click Properties.**

A dialog box appears, where you can set up your printer driver.



Note

Please note that the procedure for opening the dialog box to set up the printer driver may slightly differ from one application to another.

2. **Set the Document Type according to the print data.**
3. **Set the Media Type to Transparency Film.**

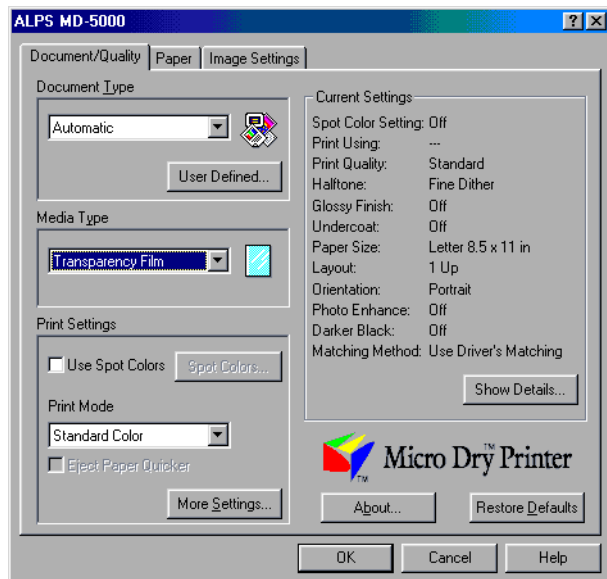

4. **Change the Color and other options as necessary.**
5. **When you complete all the setup, click OK to close the dialog box.**

Step 5 ► Print

1. **Click OK in the Print dialog box.**
Printing will start..

Undercoating with a VPhoto Primer Ink Cartridge

A VPhoto Primer ink cartridge can be used to print undercoat. Undercoat fills the unevenness of paper surface so that many plain paper will be suitable for printing.

Requirements

For undercoating, you will need the following.

- **Ink cartridges**

VPhoto Primer ink cartridge (Part No. 105142-00)

- **Media**

Any plain paper for copier can be used.



Caution

Iron-on transfer sheets, back print films, and overhead projector transparencies cannot be printed with VPhoto Primer ink.

Step 1 ► Prepare the Image to Be Printed As Undercoat

Use any application to create the image or document in grayscale making the undercoat.



Note

White portions of data (R=G=B=100%) are not undercoated.

Step 2 ► Install the Ink Cartridge

Make sure at least one VPhoto Primer ink cartridge is installed in the ink cartridge holders. The ink cartridge can be installed in any holder.

Step 3 ► Load the Paper in Your Printer

The method used for loading paper depends on the paper type. Use manual feed mode for cardboard (thick paper) and greeting cards. For plain paper or laser paper, you may also use automatic feed mode to print a number of sheets at one time. For details, see the section entitled "Loading Paper" in Chapter 1.

1. **For manual feed mode, set the paper feed switch to position "M"; for automatic feed mode, set it to "A".**

2. For Letter paper, fully extend the paper support.
3. Adjust the paper feed guide to the width of the paper.
4. For manual feeding, load one sheet of paper into the sheet feeder and press the ready/insert button. For automatic feeding, load all of the sheets together.

Step 4 ► Set Up the Printer Driver for Printing

1. Select Print from the File menu to open the Print dialog box, then click Properties.

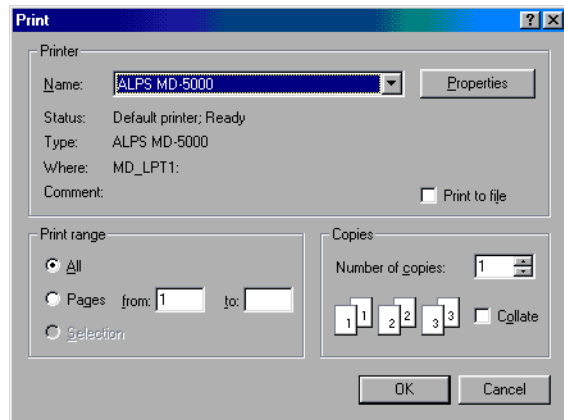

2. Click the Document/Quality tab to bring this portion to the front.
3. Set Document Type to an option appropriate to the document to be printed.
4. Set Media Type depending on the paper used.
5. Check Use Spot Colors check box so that the Spot Colors dialog box is displayed.
6. Click the Use Spot Color(s) radio button.

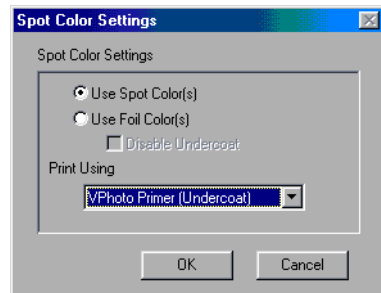
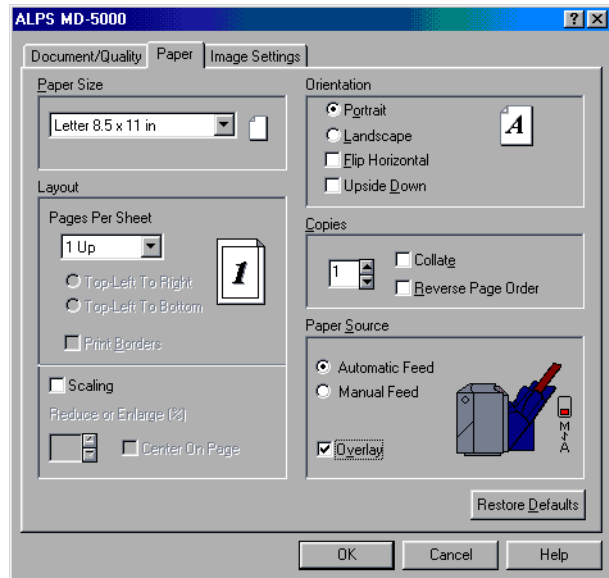
7. Set Print Using to VPhoto Primer (Undercoat).**8. Click OK to close the dialog box.****9. Click the Paper tab to bring this portion to the front, then check the Overlay check button.****10. When you complete the setup, click OK to close the dialog box.**

Step 5 ► Print

Click OK in the Print dialog box to start printing. Your document will be printed using VPhoto Primer ink.

**Note**

The Overlay function lets you leave a sheet in the printer after a printing pass is complete, so that you can change cartridges and print additional colors on the same page.

Step 6 ► Print on Undercoat

After the printing completes, you can print your document onto the undercoat.

Printer Driver

Printer Driver Functions

This chapter describes each of the printer driver settings required for controlling the printing operations. Read it to learn the specific setup details for different printing modes.

Printer Driver Setup Dialog Box

How to Open the Printer Driver Setup Dialog Box

You may open the printer driver setup dialog box in one of the following ways.

- Select Print from the File menu, and then click Properties in the Print dialog box.

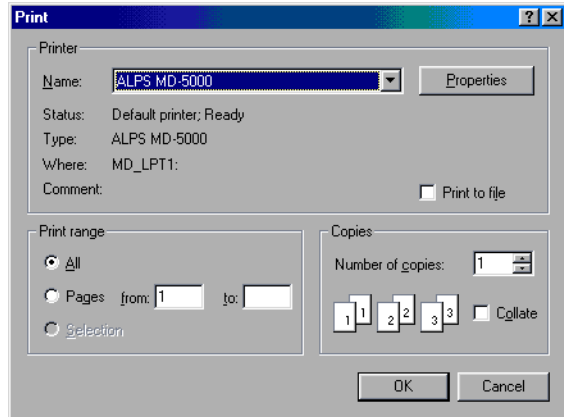

- Select Page Setup from the File menu. Click Printer in the Page Setup dialog box, and then click Properties in the displayed dialog box.

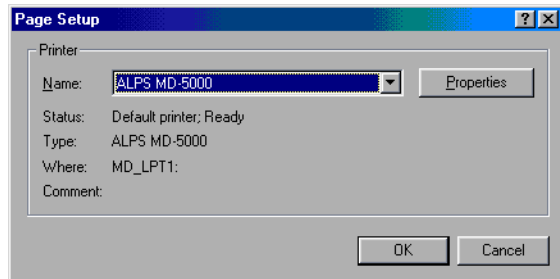

- If you are using a Windows 3.1 application, open the Printer Setup dialog box, and then click the Options button.



Note

To set up the printer driver in the Printer Setup and other dialog boxes, you must first select ALPS MD-5000 as the default printer.

Name and Functions of Each Item of the MD-5500 Dialog Box

The name and functions of each item of the MD-5500 dialog box are shown below.

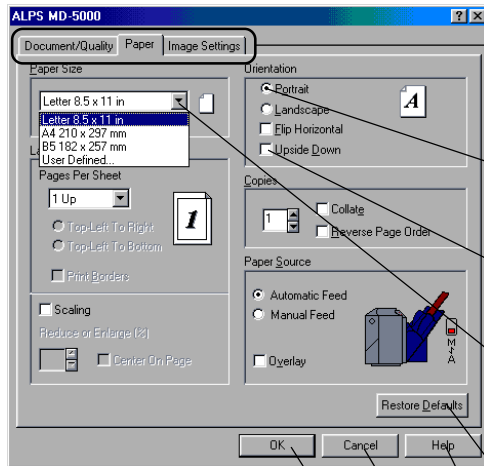

Tabs

You get access to different tab items by clicking one of the tabs. Click on a tab to display the selected tab items.

Radio buttons

You may select one of the displayed options by clicking on a button.

Check boxes

When you check a box, the option is turned on. Unchecking a box turns off the option.

Drop down list

You may select one of the displayed options. Click the button to display the available options, and then click a desired item.

Default button

Clicking on this button selects the original factory settings.

Help button

Clicking on this button displays help information for the ALPS MD-5500 dialog box.

Cancel button

Clicking on this button discards any changes and closes the dialog box.

OK button

Clicking on this button saves any changes and closes the dialog box. Click on it when you complete all the settings in all the tabs.

Settings in Each Tab

Document/Quality Tab

This tab allows you to select a Document Type, Media Type, and a few other settings.

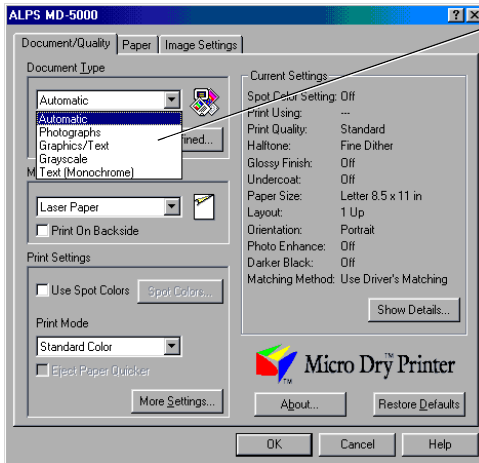

Document Type

Click the down arrow, and select the desired document type from the displayed settings. The available options are as follows:

- **Automatic**
Use this option to have the MD-5500 printer driver automatically select a document type from among the options that follow, depending on the document being printed.
- **Graphics/Texts**
Use this option when printing a business document that includes some graphics. The colors often used in business documents, such as red and blue, will be printed more vividly.
- **Photographs**
Use this option when printing color photographs. Choosing this option automatically turns on the Darker Black option in the Image setting, so that the black portions of color photographs are blended more naturally.
- **Grayscale**
Use this option when printing a monochrome graphic image or printing a color image in monochrome.
- **Text (Monochrome)**
In contrast to Grayscale mode, this option produces images without halftoning. All shades of gray will be printed as either black or white.
- **User Defined... button**
Click this button to save your own setting as a document type with your desired name. To do this, after setting the necessary items, click this button so that the User Defined Document Type dialog box is displayed.. Type the document type name in the Save as field, then click the Save button. Up to ten document types can be saved. To delete a document type, click the document type name you want to delete in the List, then click the Delete button.

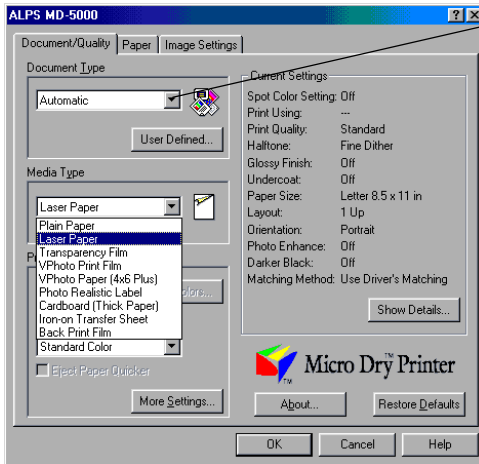

Media Type

Click the down arrow, and select a media paper from the displayed options. The available Media Type options depend on the Document Type settings. The available options are as follows:

- **Plain Paper**
Select this for printing on plain paper.
- **Laser Paper**
Select this for printing on laser quality paper with a smooth surface or Alps High Grade Paper.
- **Cardboard (Thick Paper)**
Select this for printing on cardboard or thick paper.
- **Transparency Film**
Select this for printing on Alps overhead projector transparencies.
- **Iron-on Transfer Sheets**
Select this for printing on Alps iron-on transfer sheets.
- **Back Print Film**
Select this for printing on Back Print Film.
- **Photo Realistic Label**
Select this for printing on Alps Photo Realistic Labels.
- **VPhoto Print Film**
Select this for printing on VPhoto Print Film. You can print the photo quality images at 2400 dpi variable dots using standard CMYK ink cartridges.
- **VPhoto Paper (4x6" Plus)**
Select this for printing on VPhoto Paper (4x6" Plus). You can print the photo quality images at 2400 dpi variable dots using standard CMYK ink cartridges.
- **Photographic Paper**
Select this for printing on Alps Photographic Quality Paper (Letter, or 4"x6" size). You can print the continuous-tone, photographic quality images using Photo ink cartridges.
- **Photographic Label**
Select this for printing on Alps Photographic-Quality Labels. You can print the continuous-tone, photographic quality images using Photo ink cartridges.

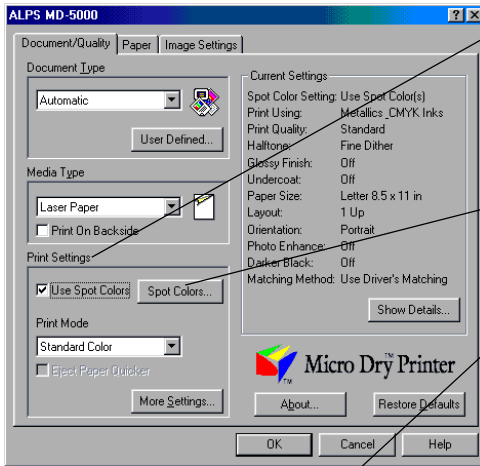

Print Settings

This option allows you to select Spot Color and Print Mode settings.

- **Use Spot Colors check box**
Click this option to display the Spot Colors Settings dialog box, where you can select the spot color printing options.
- **Spot Colors... button**
While the Use Spot Colors is selected, you can click this button to display the Spot Colors dialog box.
- **Spot Color Settings dialog box**
Select a spot color options.
- **Use Spot Color(s) radio button**
Select this option to print using Metallic (Gold, Silver, Cyan, Magenta), White, Finish, and VPhoto Primer ink cartridges.

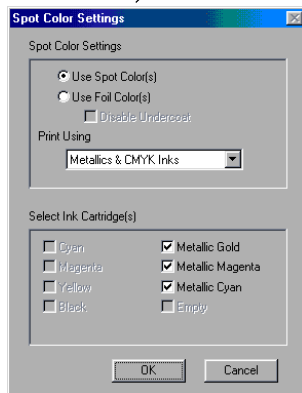

- **Use Foil Color(s) radio button**
Select this option to print using the Gold Foil and Silver Foil ink cartridges.
- **Disable Undercoat check box**
This option can be selected when the Use Foil Color(s) is selected. To print foil color without using the undercoat of CMYK inks, select this option. Note that disabling undercoat may appear poor quality, since the foil color requires the undercoat.
- **Print Using**
This option allows you to select the cartridge(s) for Spot color and Foil color printing you selected.

- **Single Ink**
Select this option to print using a single spot color. Cyan, magenta, yellow, black and white can also be set as the single color.
- **Multiple Inks**
Select this option to print using two or more spot colors. The spot colors should be designated by corresponding color components.
- **Metallics & CMYK Inks**
Select this option to print your document using standard CMYK and Spot , or Foil color ink cartridges.
- **White (Undercoat)**
Select this option to print the undercoat using White ink cartridge. This function is used in Overlay mode.
- **Glossy Finish**
Select this option to obtain the photograph like glossy print using Finish ink cartridge. This function is used in Overlay mode.
- **VPhoto Primer (Undercoat)**
Select this option to print the undercoat using VPhoto Primer ink cartridge. This function is used in Overlay mode.

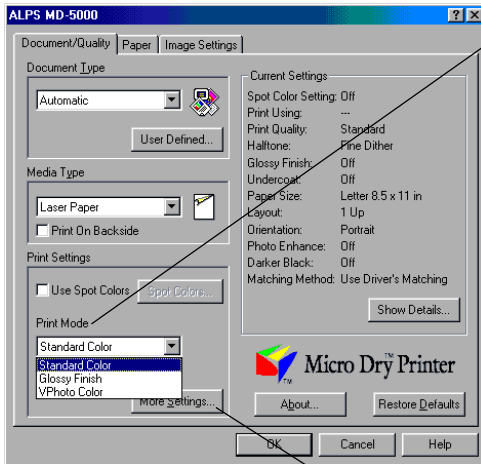

Print Mode

This option allows you to select Print Mode.

- **Standard Color**
Select this option to execute printing in the mode optimal for the media selected.
- **Economy Black**
Select this to print rough drafts of text document using EconoBlack ink cartridge (reversible up to 20 times.)
- **Glossy Finish**
Select this option to obtain the photograph like glossy print using Finish ink cartridge.
- **VPhoto Color**
Select this to print photo quality images using variable dots at 2400 dpi.
- **Dye Sublimation**
Select this option to print dye sublimation, continuous-tone printing on the Photographic Quality Paper using Photo ink cartridges.

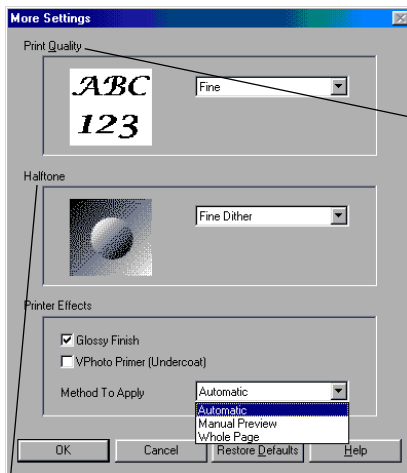

More Settings

Click this button to open the More Settings dialog box, where you can select Print Quality, Halftone and Printer Effects options.

Print Quality

This option allows you to select print quality at which your document will be printed.

- **Super**
To print at Super print quality (16 tones, 2400 dpi using variable dots).
- **Fine**
To print at Fine print quality (4 tones, 2400 dpi using variable dots).
- **Standard**
To print at 600 dpi, Standard print quality for common document.

Note

The list of available options varies depending on the Document Type and Media Type you have selected, and some options are not available for all ALPS printers.

Halftone

The option allows you to select the method of dot placement used to create colors. With rough paper, the Standard Dither may produce a better printed image.

- **No Halftone**
Halftone is not used. The image is printed in black and white only. Areas over 50% gray are printed as solid black.
- **Fine Dither**
To use Fine Dither pattern of dots to create blended colors.
- **Standard Dither**
To use Standard Dither pattern of dots to create blended colors appropriate for most situations.

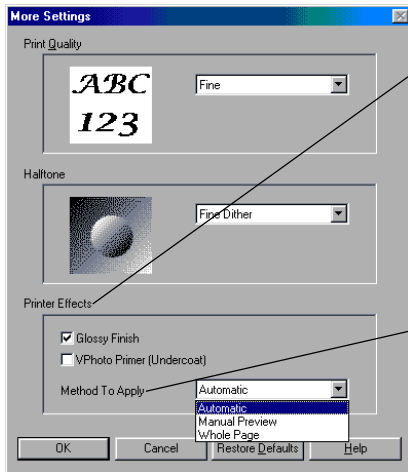

Printer Effects

This option allows you to select Glossy Finish and VPhoto Primer (Undercoat). This option is linked with the Print Mode setting in the Document/Quality tab.

- **Glossy Finish check box**

Select this option to obtain the photograph like glossy print using Finish ink cartridge.

- **VPhoto Primer (Undercoat) check box**

Select this option to print the undercoat using VPhoto Primer ink cartridge that enables photo-quality print on any plain paper.

Method to Apply

Select a method to apply the printer effects of glossy finish and undercoat.

- **Automatic**

This option applies the printer effects automatically to the images. Use Manual Preview to manage the printer effects, if you want to do so.

- **Manual Preview**

This option allows you to specify the area where the printer effects to be applied using the Printer Effects Preview window. Windows 3.1 does not support this feature.

- **Whole Page**

To apply the printer effects to entire page.

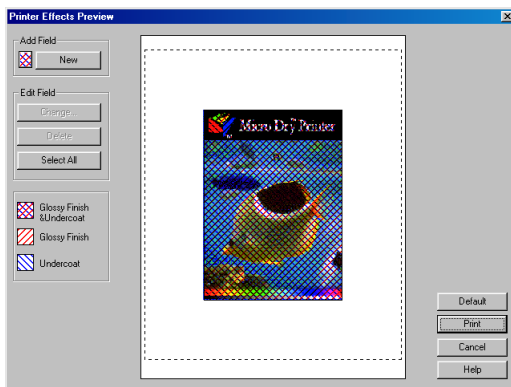

Printer Effects Preview

The Printer Effects Preview allows you to view and edit the printer effects of Undercoat and Glossy Finish. You can create new field to add, change its printer effects, and edit it to resize or move prior to printing your print job.

- **Adding the NEW field:**

1. Click on the NEW button.
2. Position the cursor where you want the rectangle to appear.
3. Click and drag to draw the shape.

- **Changing the printer effects:**

1. Right-click on the field to display its selectable printer effects.
2. Select the printer effects to change.

- **Resizing the field:**

1. Click on the field to select.
2. Drag one of the corner or size selection handles inward to decrease the size, or outward to increase its size.

- **Moving the field:**

1. Click on the field to select.
2. Drag the field to a new place in your preview window.

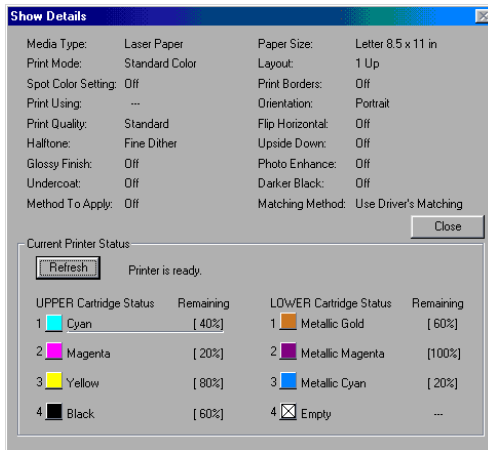

Show Details dialog box

This Show Detail dialog box displays the current settings.

- **Status Display**

This status display area shows you all settings currently selected in the printer driver. It also displays the information of the installed ink cartridges.

- **Refresh button**

Click Refresh button to refresh and update the latest printer status. You can click on the ink color indicator to select it, then click Refresh button updates individually.

- **Close button**

Click Close to close the Show Details dialog box.

Paper Tab

This tab allows you to select a paper size and a few other settings.

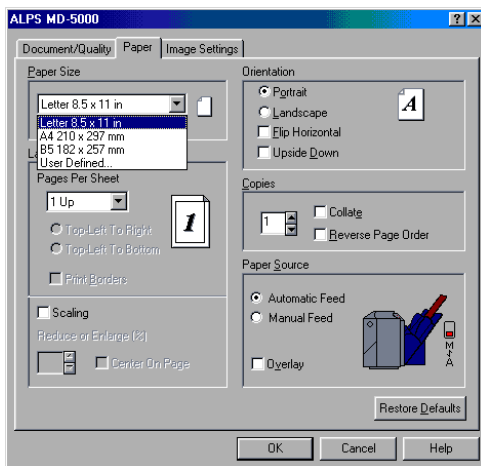

Paper Size

Click the down arrow, and select a paper size from the displayed options. The available options are as follows:

- Letter 8.5 x 11 in
- A4 210 x 297 mm
- B5 182 x 257 mm
- Photo Paper 4 x 6 in
- Photo Label 100 x 148 mm
- Photo Label 100 x 164 mm
- User Defined...

To open the User Defined Paper Size dialog box, select the User Defined... option from the Paper Size menu. In this dialog, you can create your custom paper size. Enter the width and length, and type name of your custom paper size. Then click Save to save the settings. Up to ten settings can be saved. To delete a setting, click the saved name in the list, then click the Delete button.

- **VPhoto Paper (4x6" Plus)**

When VPhoto Paper (4x6" Plus) is selected in Media Type, the paper size is fixed to VPhoto Paper (4x 6" Plus).

- **Photo Realistic Label**

When Photo Realistic Label is selected in Media Type, the paper size is fixed to Photo Realistic Label.

- **Photographic Label**

When Photographic Label is selected in Media Type, the paper size is fixed to Photographic Label.

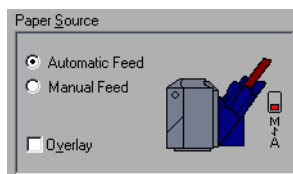
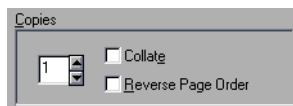
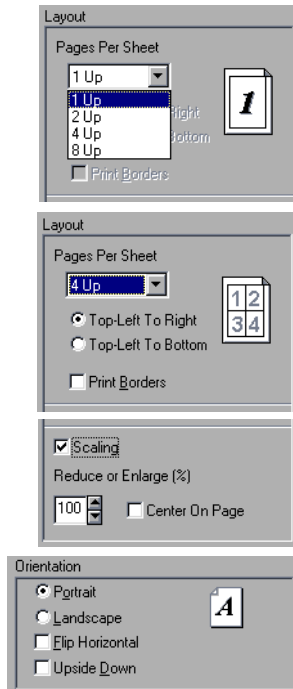

Layout

Set Pages Per Sheet and Scaling. The available options vary depending on the settings in Print Mode and Paper Size.

- **Pages Per Sheet**

Select the corresponding option to print two, four, six, or eight pages on one page. The orders of printing pages can be selected with the Top-Left T Right and Top-Left to Bottom radio buttons.

- **Print Borders check box**

Check this box to print border lines of each page.

- **Scaling check box**

Scaling can be set between 25% to 400%.

- **Center On Page check box**

Check this box to print data after executing centering.

Orientation

This setting sets the paper orientation.

- **Portrait/Landscape**

Click one of the radio buttons to set the paper orientation to either Portrait or Landscape.

- **Flip Horizontal**

Turning on this option prints an image flipped horizontally. When you select Iron-on Sheet or Back Print Film in the Media Type setting, this check box is automatically checked.

- **Upside & Down check box**

Check this box to print the image after turning it 180 degrees.

Copies

Input the number of copies to be printed by typing the number in the edit box.

Select different printing options by clicking on the check boxes.

- **Collate**

Print multiple copies in collated order.

- **Reverse Page Order**

Print in reverse order beginning with the last page.

Paper Source

This setting allows you to set the paper feed mode. The current paper feed mode is displayed in the box.

Click one of the radio buttons to select a paper feed mode appropriate for the paper type. The available modes are Automatic Feed and Manual Feed.

Set the paper feed switch of the printer as displayed on the screen.

Overlay

This option allows two consecutive pages of a document to be printed on the same sheet. Use this option when printing metallic color data, and then full color data. This option is not available when Metallic with Full Color has been selected in the Document Type setting.

Image Settings Tab

Set the brightness, contrast, and color balance of the printed image in this tab.

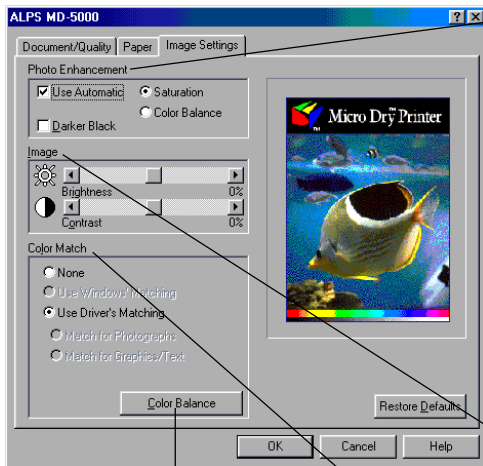

Photo Enhancement

This option allows you to select either automatic saturation or color balance.

When Use Automatic option is selected, you can use Saturation or Color Balance option.

- **Saturation**
To increase the contrast in an image.
- **Color Balance**
To intensify the colors and lighten the midtones in an image.
- **Darker Black**
When this box is checked, black is created using all four inks (cyan, magenta, yellow, and black), so that the black portions of a color photograph or other graphic are blended more naturally.

Image

Adjust the brightness and contrast of the image by moving the sliders.

Increasing the brightness makes the entire image brighter. Increasing the contrast intensifies the differences between light and dark areas.

Color Match

This setting allows the printer to adjust colors according to the data type, for higher color printing quality. The available options are as follows:

- **None**
No color matching.
- **Use Driver's Matching**
Color matching is performed automatically by the printer driver.
- **Match for Graphics/Texts**
Colors are adjusted for business documents that contain some graphics. When Graphics/Texts is selected in the Document Types setting, this option is automatically selected.
- **Match for Photographs**
Colors are adjusted for photographs or illustrations. When Photographs is selected in the Document Types setting, this option is automatically selected.

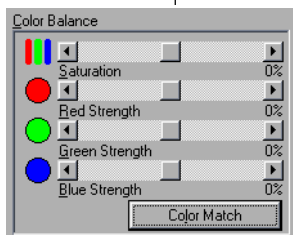

Color Balance

This setting allows you to adjust the color balance of the printed image. Click on the Color Balance button to display the color balance setup sliders. Move the sliders to change the color balance settings.

- **Saturation**
Adjusts the color intensity of the printed image. Moving the slider to the right intensifies the colors, and makes the printed colors more vivid. Moving it to the left reduces the color intensity, and makes the printed colors more dull.
- **Red Strength**
Adjusts the brightness of red in the printed image. Moving the slider to the right intensifies red, while moving it to the left reduces the intensity of red.
- **Green Strength**
Adjusts the brightness of green in the printed image. Moving the slider to the right intensifies green, while moving it to the left reduces the intensity of green.
- **Blue Strength**
Adjusts the brightness of blue in the printed image. Moving the slider to the right intensifies blue, while moving it to the left reduces the intensity of blue.